

AQUAHOME

bathkitchen style

EDICIÓN
2022 | 2023



AQUAHOME BATHKITCHEN STYLE S.L
Apdo. de correos 102
28600 Navalcarnero (Madrid)



Tel: +34 617 430 609
+34 617 430 503
+34 912 797 457



www.aquahomebs.com



comercialventas@aquahomebs.com
departamentocomercial@aquahomebs.com
direccioncomercial@aquahomebs.com

AQUAHOME

bathkitchen style



El agua como medio
de vida

SOBRE NOSOTROS

Somos una empresa dedicada a la creación de espacios de hogar desde su fabricación hasta su comercialización. Trabajamos con productos sanitarios tales como grifería, columnas de ducha y otros complementos, tanto para baño como para cocina.

Contamos con más de 30 años de experiencia en este mercado. Comenzamos nuestra andadura en la zona centro y poco a poco hemos ido creciendo hasta conseguir una amplia red de representación comercial en todo el territorio español, Portugal y algunos países europeos, convirtiéndonos en un referente a nivel nacional en el sector.

Elegimos a conciencia las materias primas que utilizamos así como los mejores países de producción garantizando de esta forma el máximo rendimiento de nuestros productos y la mejor calidad. Por eso todos los artículos y sus componentes son sometidos a diferentes pruebas de resistencia, durabilidad y confort para obtener los mejores resultados.

Ofrecemos 5 años de garantía en nuestros productos, apostando por la calidad y el control, con una producción sostenible bajo estándares de garantía: ISO 9001, AENOR, TÜV.

Hoy en día sabemos que ahorrar agua es una de las mayores preocupaciones que nos conciernen. La conservación de nuestro planeta o el uso de fuentes de energía renovables es nuestro principal objetivo, por ello debemos asegurarnos de que este elemento de la naturaleza tanpreciado no sea malgastado.

Política de entrega 48/72h.

Red comercial con más de 20 agentes profesionales.

Servicio telefónico post venta +34 617 430 609

Email att. cliente: comercialventas@aquahomebs.com

ABOUT US

We are a company dedicated to the creation of spaces of bath, from his manufacture to his commercialization, with sanitary products as faucets, columns and other complements as well as for bathroom or kitchen.

We have over 30 years of experience working in the sector We began our way in the center of the peninsula and little by little we have been growing up to obtaining a wide net of commercial representation in the whole Spanish territory, Portugal and some other European countries, becoming a national reference into the sector.

We choose our raw materials conscientiously, as well as the best countries of production, guaranteeing this way the maximum yield of products and the best quality. All ourproducts and his components are submitted to different endurance, durability and comfort tests.

We bet for best quality and control with a sustainable way of production under standards of guarantee: ISO 9001, AENOR, TÜV, etc. It is for, that we offer 5 years of guarantee in our products.

Nowadays we know that saving water is one of the major worries that concern us. The conservation of our planet or the use of renewable sources of energy is our principal aim, for this reason we must make sure that this precious element of nature should remain.

Delivery policy 48/72h

Commercial networking with more than 20 professional agents.

Post sale telephone service. +34 617 430 609

customer service email: comercialventas@aquahomebs.com

INFORMACIÓN ADICIONAL IMPORTANTE

- Garantía de 5 años.
- Nuestra grifería dispone de un sistema "Easyfit" que permite un montaje manual y sin utilizar herramientas.
- Nuestra grifería incorporan aireadores anti-calcáreos que aseguran el perfecto flujo de agua y garantizan un chorro perfecto y duradero, así como un filtro atomizador con reductor de caudal.
- Incorporamos válvulas anti-retorno en todos los grupos de grifería de baño y baño-ducha, reduciendo así el caudal y economizando agua.
- Todos nuestros latiguillos (conexiones flexibles) cumplen con la Normativa AENOR.
- Todos los cartuchos son de disco cerámico, normalizados AENOR, y bajo pedido disponemos de cartuchos de APERTURA EN FRÍO (Presupuesto a consultar).
- Toda nuestra grifería, tanto de baño como de ducha, incluyen mango, flexo de ducha y soporte para pared.

ADDITIONAL IMPORTANT POINTS

- 5-year warranty.
- The company has a comfortable and easy system of fixing which can be instantly and safely mounted, with out any tools "Easy fit".
- Aquahome taps include antical aerators which ensure the perfect water flow and guarantee a perfect and long lasting running water, as well as dirt filter and pressure reducer for all of them.
- We also add check valves in every plumbing group, reducing in this way the flow and saving water.
- All flexible tap hoses are standarized and receive ISO and AENOR certification.
- All cartridges has ceramic disk, standarized AENOR, and in special orders we can bring those who has cold opening (Ask for a customised quote).
- All the plumbing we produce, Bath mixers and shower mixers, include handshower, hose and wall holder.

BAÑOS DE LACADO ELECTROFORÉTICO

Hoy en día vivimos en una era donde el sector industrial demanda procesos altamente eficientes y que se adecúen perfectamente a las normativas medioambientales vigentes, siendo la electroforesis una de las alternativas más atractivas para la sustitución de procesos convencionales menos sostenibles como, por ejemplo, la aplicación de pintura epoxy.

El proceso de Deposición Electroforética (EPD por sus siglas en inglés, Electrophoretic Deposition), es un proceso coloidal cuya ventaja principal radica en su capacidad de depositar recubrimientos en un corto espacio de tiempo, sin necesidad de equipamiento costoso y a precio competitivo.

Esta nueva tecnología aplicada a nuestros productos principalmente con acabados especiales, negro, oro rosa, oro cepillado... etc. se puede describir como un cruce entre galvanoplástia y pintura, donde el latón se sumerge en una solución a base de agua que contiene una emulsión de pintura, aplicada a un voltaje eléctrico sobre la pieza para emulsionarla y que se condense. Una vez aplicada dicha técnica se cura con una temperatura específica para terminar el acabado.

Todo esto nos proporciona una serie de ventajas:

- Evitar las huellas en la grifería gracias al recubrimiento que se produce en el horno, creando una película aislante.
- Recubrimiento uniforme, tanto interior como exterior. La EDP proporciona una textura fina y uniforme, matificando el producto y dándole un acabado más atractivo y de mayor calidad.
- Rendimiento anticorrosión mejor, incluso, que el acabado cromo.

ELECTROPHORETIC LAQUERED BATHS

Hoy en día vivimos en una era donde el sector industrial demanda procesos altamente eficientes y que se adecúen perfectamente a las normativas medioambientales vigentes, siendo la electroforesis una de las alternativas más atractivas para la sustitución de procesos convencionales menos sostenibles como, por ejemplo, la aplicación de pintura epoxy.

El proceso de Deposición Electroforética (EPD por sus siglas en inglés, Electrophoretic Deposition), es un proceso coloidal cuya ventaja principal radica en su capacidad de depositar recubrimientos en un corto espacio de tiempo, sin necesidad de equipamiento costoso y a precio competitivo.

Esta nueva tecnología aplicada a nuestros productos principalmente con acabados especiales, negro, oro rosa, oro cepillado... etc. se puede describir como un cruce entre galvanoplástia y pintura, donde el latón se sumerge en una solución a base de agua que contiene una emulsión de pintura, aplicada a un voltaje eléctrico sobre la pieza para emulsionarla y que se condense. Una vez aplicada dicha técnica se cura con una temperatura específica para terminar el acabado.

Todo esto nos proporciona una serie de ventajas:

- Evitar las huellas en la grifería gracias al recubrimiento que se produce en el horno, creando una película aislante.
 - Recubrimiento uniforme, tanto interior como exterior. La EDP proporciona una textura fina y uniforme, matificando el producto y dándole un acabado más atractivo y de mayor calidad.
 - Rendimiento anticorrosión mejor, incluso, que el acabado cromo.
- 



Energy saving

ÍNDICE DE CONTENIDOS



Cromo



Negro mate



Oro cepillado



Oro rosa cepillado

GRIFERÍA DE BAÑO

Serie Alsacia	12	14		
Serie Malibú	18	20		
Serie Manila (Noviembre 2022)	24	26	28	30
Serie Bora Bora	32		34	
Serie Bel air	38	40	42	
Lavabo encastrar	44	44	44	
Ducha encastrar monomando / termostática	45	45	45	
Serie New Twist (Noviembre 2022)	48	50		
Serie Twist	52			
Lavabo encastrar	54	54		
Ducha encastrar / Baño encastrar	55	55		
Serie Cascada	56			
Serie París	58			
Serie Munich	62			
Serie Lisboa	64			
Serie Lyon	68			
Serie Sprinter	72			
Serie Cádiz	74			
Serie Época	76		78	
Grifería de bañera exenta	82-85	82-85		
Columnas de grifería				
Termostáticas	88-90	88-90		
Monomando	92-97	92-97	95	
Sin grifería	99	99		



Cromo

Negro
mateOro
cepilladoOro rosa
cepillado

Grifería termostática	100
------------------------------	-----

Accesorios

Barras de ducha	102	102	102	102
Complementos	102-107	102-107		

Sustitutivos de bidet	109	109
------------------------------	-----	-----

Grifería temporizada	110
-----------------------------	-----

Grifería de pedal	111
--------------------------	-----

Grifería electrónica	111
-----------------------------	-----

GRIFERÍA DE COCINA

Monomando	114-132	117-120	117	
Muelle industrial (Noviembre 2022)	126			126
Monobloc	133			

Sistemas de evacuación	136	136	136	136
-------------------------------	-----	-----	-----	-----

Accesorios de movilidad / Colectividades	138
---	-----

Accesorios de baño	141	141
---------------------------	-----	-----

Repuestos	142
------------------	-----

**GRIFERÍA
DE BAÑO**





SERIE MONOMANDO

ALSACIA

- Cuerpo latón cromado
- Cartucho cerámico 35mm normalizado
- Conexiones flexibles normalizadas AENOR
- Atomizador de latón
- Rosca de sujeción



CROMO

LAVABO ALTO CROMO

ACABADO

- Cromo

REF. 11640212701 **145,00€**

EAN 8427 0000 37997

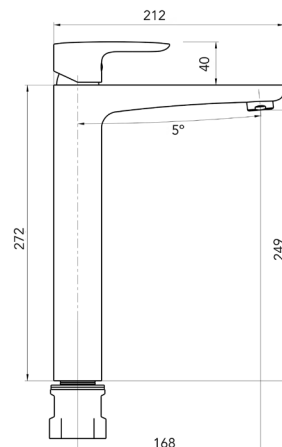

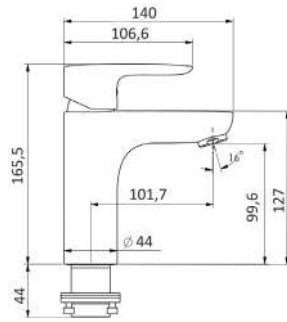

LAVABO CROMO

ACABADO

- Cromo
REF. 11640112701 **79,00€**

EAN 8427 0000 03756

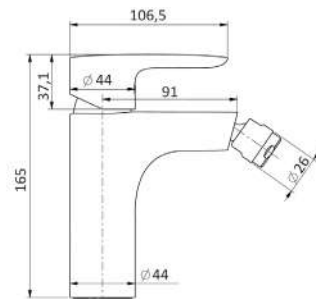

BIDÉ CROMO

ACABADO

- Cromo
REF. 11641112701 **79,50€**

EAN 8427 0000 03763

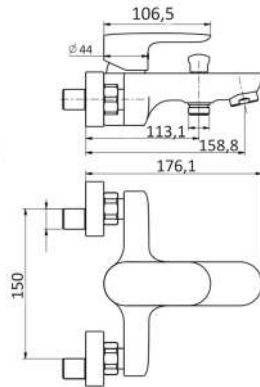

BAÑO DUCHA CROMO

Excéntricas latón niquelado, con florón cromo

Incluye: manual de ducha anti-cal, soporte articulado en ABS y flexo de metal reforzado cromado

ACABADO

- Cromo
REF. 11642112701 **130,00€**

EAN 8427 0000 03770

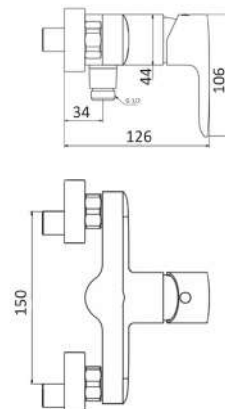
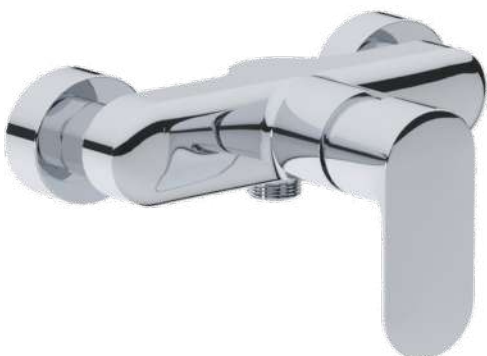

DUCHA CROMO

Excéntricas latón niquelado, con florón cromo

Incluye: manual de ducha anti-cal, soporte articulado en ABS y flexo de metal reforzado cromado

ACABADO

- Cromo
REF. 11643112701 **99,00€**

EAN 8427 0000 03787

SERIE MONOMANDO

ALSACIA

- Cuerpo latón negro mate sistema lacado electrofóresis
- Cartucho cerámico 35mm normalizado
- Conexiones flexibles normalizadas AENOR
- Atomizador de latón
- Rosca de sujeción



SISTEMA LACADO
ELECTROFÓRESIS

LAVABO ALTO NEGRO MATE

ACABADO

- Negro

REF. 11640212705

155,00€

EAN 8427 0000 37898

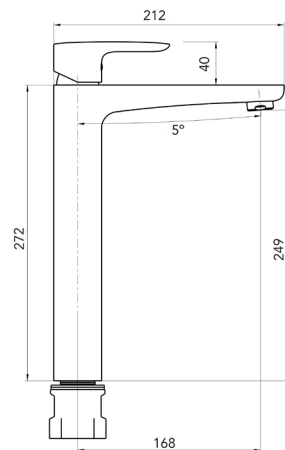

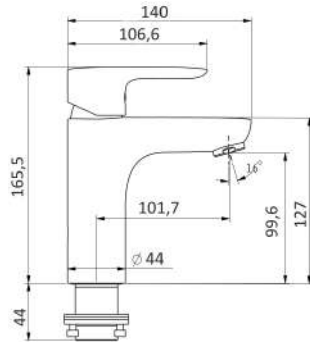

LAVABO NEGRO

ACABADO

- Negro
REF. 11640112705 **94,00€**

EAN 8427 0000 03701

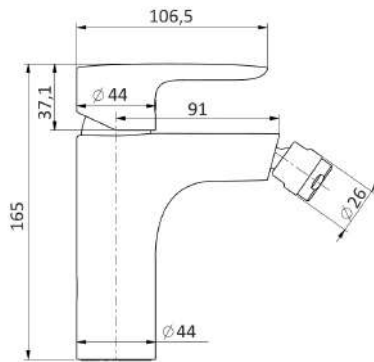

BIDÉ NEGRO

ACABADO

- Negro
REF. 11641112705 **94,00€**

EAN 8427 0000 03718

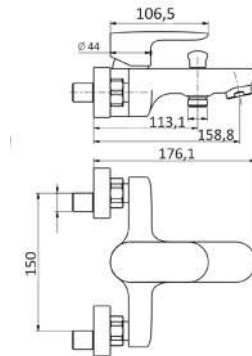

BAÑO DUCHA NEGRO

Excéntricas latón niquelado, con florón negro mate

Incluye: manual de ducha anti-cal, soporte articulado en ABS y flexo de metal reforzado negro mate

ACABADO

- Negro
REF. 11642112705 **146,50€**

EAN 8427 0000 03725

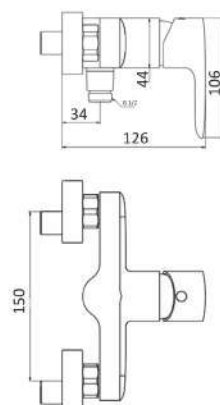

DUCHA NEGRO

Excéntricas latón niquelado, con florón negro mate

Incluye: manual de ducha anti-cal, soporte articulado en ABS y flexo de metal reforzado negro mate

ACABADO

- Negro
REF. 11643112705 **125,50€**

EAN 8427 0000 03732

SERIE

MALIBÚ





SERIE MONOMANDO

MALIBÚ

- Cuerpo latón cromado
- Cartucho cerámico 35mm normalizado
- Conexiones flexibles normalizadas AENOR
- Atomizador de latón
- Rosca de sujeción



CROMO

LAVABO ALTO CROMO

ACABADO

- Cromo

REF. 11940212701 **125,50€**

EAN 8427 0000 09222

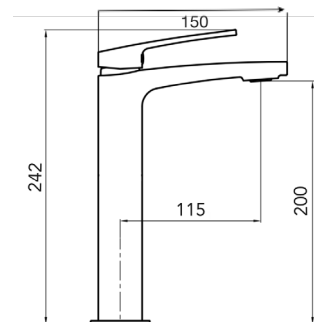

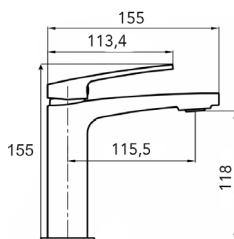

LAVABO CROMO

ACABADO

- Cromo
REF. 11940112701 **86,50€**

EAN 8427 0000 09239

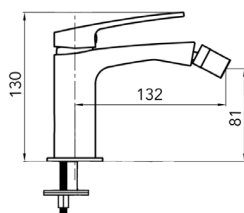

BIDÉ CROMO

ACABADO

- Cromo
REF. 11941112701 **88,50€**

EAN 8427 0000 09246

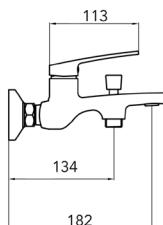

BAÑO DUCHA CROMO

Excéntricas latón niquelado, con florón cromo

Incluye: manual de ducha anti-cal, soporte articulado en ABS y flexo PVC cromo

ACABADO

- Cromo
REF. 11942112701 **119,50€**

EAN 8427 0000 09253

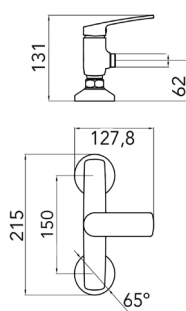

DUCHA CROMO

Excéntricas latón niquelado y florón cromo

Incluye: manual de ducha anti-cal, soporte articulado en ABS y flexo PVC cromo

ACABADO

- Cromo
REF. 11943112701 **94,50€**

EAN 8427 0000 09260



SERIE MONOMANDO

MALIBÚ

- Cuerpo latón negro mate sistema lacado electrofóresis
- Cartucho cerámico 35mm normalizado
- Conexiones flexibles normalizadas AENOR
- Atomizador de latón
- Rosca de sujeción



NEGRO

SISTEMA LACADO
ELECTROFÓRESIS

LAVABO ALTO NEGRO MATE

ACABADO

- Negro

REF. 11940212703

145,50€

EAN 8427 0000 08812

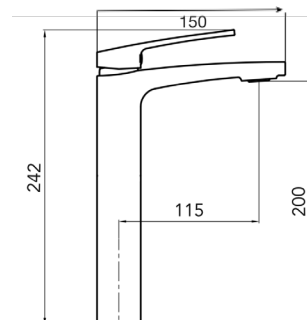

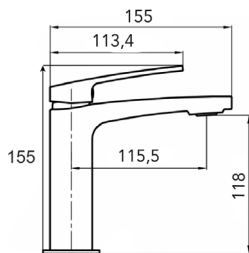

LAVABO NEGRO

ACABADO

- Negro
REF. 11940112703 **99,00€**
EAN 8427 0000 08829

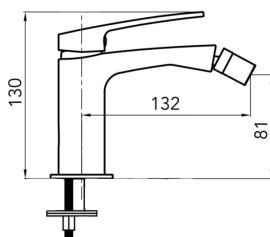

BIDÉ NEGRO

ACABADO

- Negro
REF. 11941112703 **99,00€**
EAN 8427 0000 08836

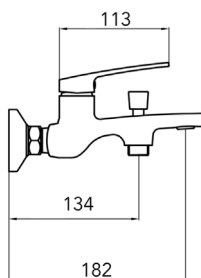

BAÑO DUCHA NEGRO

Excéntricas latón niquelado y florón negro mate

Incluye: manual de ducha anti-cal, soporte articulado en ABS y flexo PVC negro mate

ACABADO

- Negro
REF. 11942112703 **136,00€**
EAN 8427 0000 08843

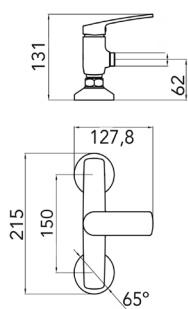

DUCHA NEGRO

Excéntricas latón niquelado y florón negro mate

Incluye: manual de ducha anti-cal, soporte articulado en ABS y flexo PVC negro mate

ACABADO

- Negro
REF. 11943112703 **106,00€**
EAN 8427 0000 08850

SERIE MANILA

MONOMANDO LAVABO MANILA ALTO CROMO

Ref. 10440212701





DISPONIBLE NOVIEMBRE 2022

SERIE MONOMANDO

MANILA

- Cuerpo latón cromado
- Cartucho cerámico 35mm normalizado
- Conexiones flexibles normalizadas AENOR
- Atomizador de latón
- Rosca de sujeción

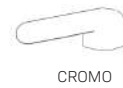

CROMO

LAVABO ALTO CROMO

ACABADO

- Cromo

REF. 10440212701

149,00€

EAN 8427 0000 03810

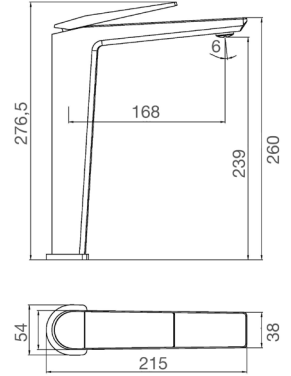

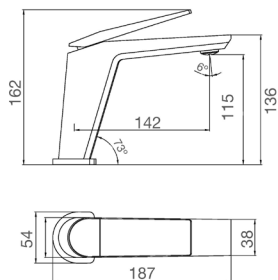

LAVABO CROMO

ACABADO

- Cromo
REF. 10440112701 **115,00€**

EAN 8427 0000 03824

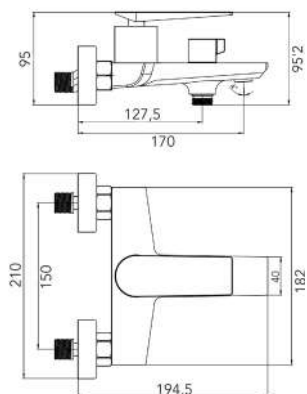

BAÑO DUCHA CROMO

Excéntricas latón niquelado y florón cromo

Incluye: manual de ducha anti-cal, soporte articulado en ABS y flexo metálico reforzado cromo

ACABADO

- Cromo
REF. 10442112701 **155,00€**

EAN 8427 0000 03831

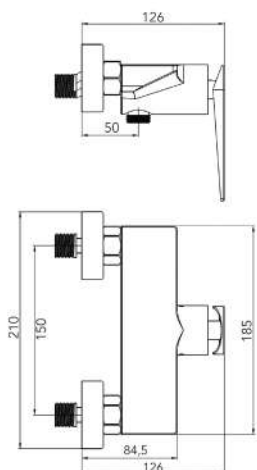

DUCHA CROMO

Excéntricas latón niquelado y florón cromo

Incluye: manual de ducha anti-cal, soporte articulado en ABS y flexo metálico reforzado cromo

ACABADO

- Cromo
REF. 10443112701 **125,00€**

EAN 8427 0000 03855

SERIE MONOMANDO

MANILA

LAVABO ALTO NEGRO MATE

ACABADO

- Negro

REF. 10440212703

159,00€

EAN 8427 0000 03862

- Cuerpo latón negro mate PVD sistema lacado electrofóresis
- Cartucho cerámico 35mm normalizado
- Conexiones flexibles normalizadas AENOR
- Atomizador de latón
- Rosca de sujeción

DISPONIBLE NOVIEMBRE 2022



NEGRO

SISTEMA LACADO
ELECTROFÓRESIS

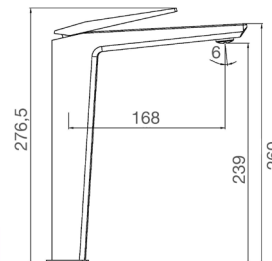

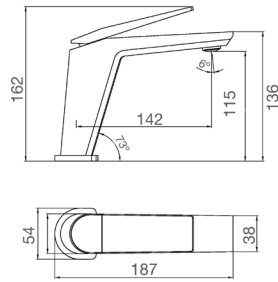

LAVABO NEGRO

ACABADO

- Negro

REF. 10440112703 **118,00€**

EAN 8427 0000 03879

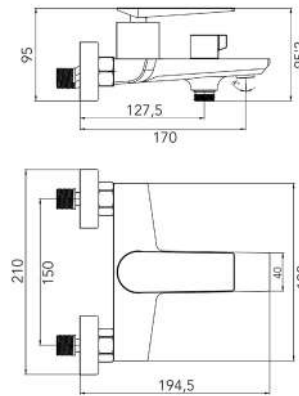

BAÑO DUCHA NEGRO

Excéntricas con florón negro mate

Incluye: manual de ducha anti-cal, soporte articulado en ABS y flexo de PVC reforzado negro mate

ACABADO

- Negro

REF. 10442112703 **162,00€**

EAN 8427 0000 03831

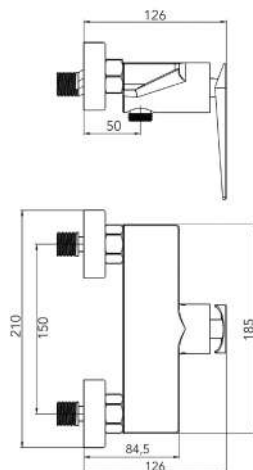

DUCHA NEGRO

Excéntricas con florón negro mate

Incluye: manual de ducha anti-cal, soporte articulado en ABS y flexo de PVC reforzado negro mate

ACABADO

- Negro

REF. 10443112703 **135,50€**

EAN 8427 0000 04401

SERIE MONOMANDO

MANILA

- Cuerpo latón negro mate sistema lacado electrofóresis
- Cartucho cerámico 35mm normalizado
- Conexiones flexibles normalizadas AENOR
- Atomizador de latón
- Rosca de sujeción

DISPONIBLE NOVIEMBRE 2022

LAVABO ALTO ORO CEPILLADO

ACABADO

- Oro cepillado

REF. 10440212708

166,50€

EAN 8427 0000 04531



ORO CEPILLADO

SISTEMA LACADO
ELECTROFÓRESIS

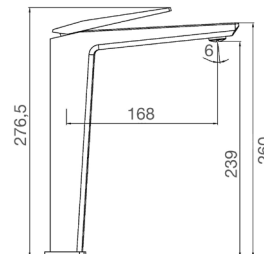

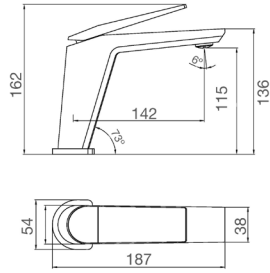

LAVABO ORO CEPILLADO

ACABADO

- Oro cepillado
 REF. 10440112708 **130,00€**
 EAN 8427 0000 04548

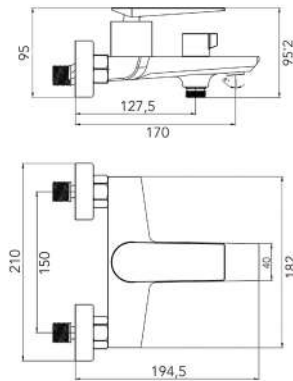

BAÑO DUCHA ORO CEPILLADO

Excéntricas con florón sistema lacado electrofóresis oro cepillado

Incluye: manual de ducha anti-cal, soporte articulado en ABS y flexo de PVC reforzado

ACABADO

- Oro cepillado
 REF. 10442112708 **175,00€**
 EAN 8427 0000 04555

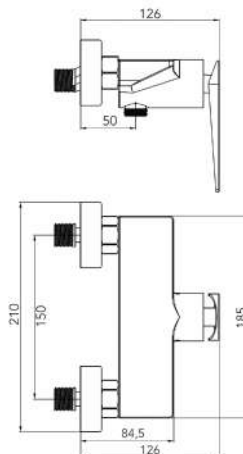

DUCHA ORO CEPILLADO

Excéntricas con florón sistema lacado electrofóresis oro cepillado

Incluye: manual de ducha anti-cal, soporte articulado en ABS y flexo de PVC reforzado

ACABADO

- Oro cepillado
 REF. 10443112708 **140,00€**
 EAN 8427 0000 04562

DISPONIBLE NOVIEMBRE 2022

SERIE MONOMANDO

MANILA

- Cuerpo latón oro rosa cepillado sistema lacado electrofóresis
- Cartucho cerámico 35mm normalizado
- Conexiones flexibles normalizadas AENOR
- Atomizador de latón
- Rosca de sujeción



ORO ROSA CEPILLADO

SISTEMA LACADO ELECTROFÓRESIS

LAVABO ALTO ORO ROSA CEPILLADO

ACABADO

- Oro rosa cepillado
REF. 10440212709

165,50€

EAN 8427 0000 04579

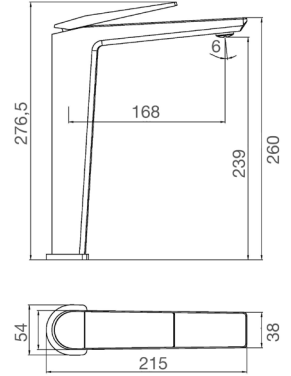

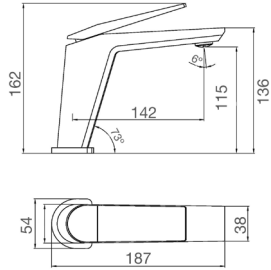

LAVABO ORO ROSA CEPILLADO

ACABADO

- Oro rosa cepillado
REF. 10440112709
EAN 8427 0000 04586

130,00€

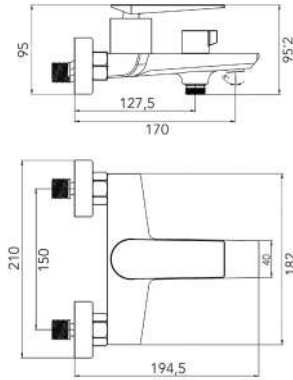

BAÑO DUCHA ORO ROSA CEPILLADO

Excéntricas con florón sistema lacado electrofóresis oro rosa cepillado

Incluye: manual de ducha anti-cal, soporte articulado en ABS y flexo de PVC reforzado

ACABADO

- Oro rosa cepillado
REF. 10442112709
EAN 8427 0000 04593

175,00€

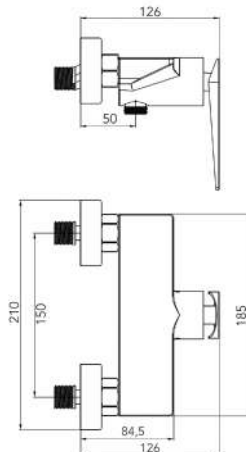

DUCHA ORO ROSA CEPILLADO

Excéntricas con florón sistema lacado electrofóresis oro rosa cepillado

Incluye: manual de ducha anti-cal, soporte articulado en ABS y flexo de PVC reforzado

ACABADO

- Oro rosa cepillado
REF. 10443112709
EAN 8427 0000 04509

140,00€

SERIE MONOMANDO

BORA BORA

- Cuerpo latón cromado
- Cartucho cerámico 35mm normalizado
- Conexiones flexibles normalizadas AENOR
- Atomizador de latón
- Rosca de sujeción



CROMO

LAVABO ALTO CROMO

ACABADO

- Cromo

REF. 13340212701

165,00€

EAN 8427 0000 04982

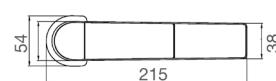
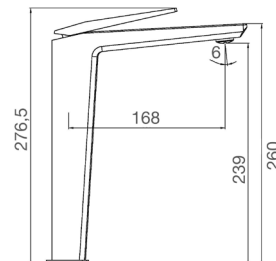

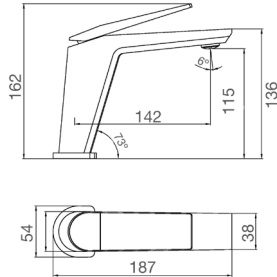

LAVABO CROMO

ACABADO

- Cromo

REF. 13340112701

115,00€

EAN 8427 0000 04999

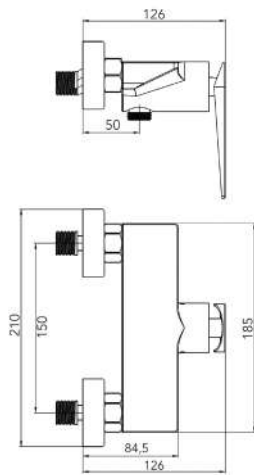

DUCHA CROMO

Excéntricas latón niquelado y florón cromo

Incluye: manual de ducha anti-cal, soporte articulado en ABS y flexo metálico reforzado cromo

ACABADO

- Cromo

REF. 13343112701

125,00€

EAN 8427 0000 05002

SERIE MONOMANDO

BORA BORA

- Cuerpo latón acabado oro cepillado sistema lacado electrofóresis
- Cartucho cerámico 35mm normalizado
- Conexiones flexibles normalizadas AENOR
- Atomizador de latón
- Rosca de sujeción



ORO CEPILLADO

SISTEMA LACADO
ELECTROFÓRESIS

LAVABO ALTO ORO CEPILLADO

ACABADO

- Oro cepillado

REF. 13340212708

185,00€

EAN 8427 0000 05019

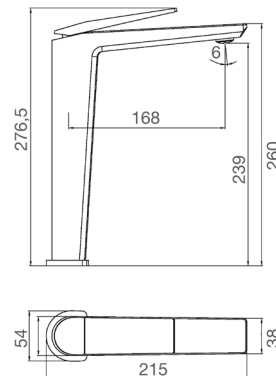

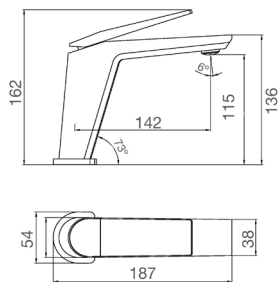

LAVABO ORO CEPILLADO

ACABADO

- Oro cepillado
REF. 13340112708 **135,00€**

EAN 8427 0000 05026

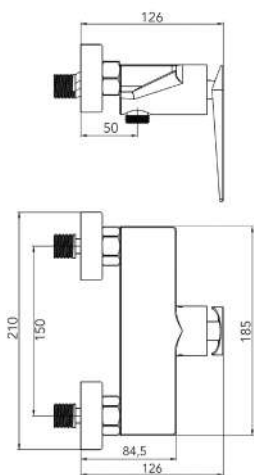

DUCHA ORO CEPILLADO

Excéntricas latón niquelado y florón oro cepillado

Incluye: manual de ducha anti-cal, soporte articulado en ABS y flexo metálico reforzado oro cepillado

ACABADO

- Oro cepillado
REF. 13343112708 **145,00€**

EAN 8427 0000 05033

SERIE
BEL AIR



LAVABO ENCASTRAR MODELO BEL AIR NEGRO MATE

Ref. 12756212703



GRIFO BAÑERA EXENTA BEL AIR NEGRO MATE

REF. 11357112203

SERIE MONOMANDO

BEL AIR

- Cuerpo latón cromado
- Cartucho cerámico 35mm normalizado
- Conexiones flexibles normalizadas AENOR
- Atomizador de latón
- Rosca de sujeción



CROMO

LAVABO ALTO CROMO

ACABADOS:

- Cromo

REF.11340212701 **105,00€**

EAN 8427 0000 37195

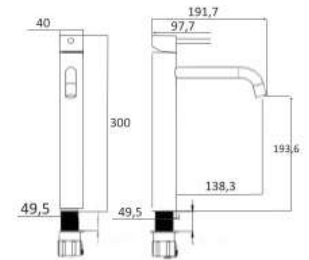

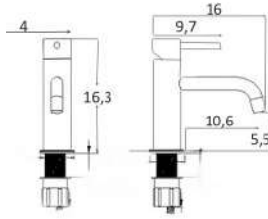

LAVABO CROMO

ACABADO

- Cromo

REF.11340112701 **82,00€**

EAN 8427 0000 37171

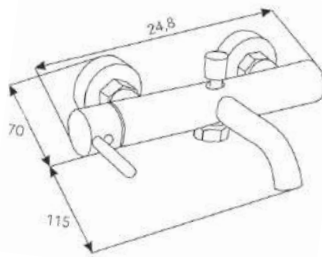

BAÑO DUCHA CROMO

Excéntricas latón niquelado y florón cromo

Incluye: manual de ducha anti-cal, soporte articulado en ABS y flexo metálico reforzado cromo

REF.11342112701 **115,50€**

EAN 8427 0000 36112

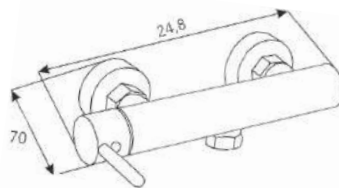

DUCHA CROMO

Excéntricas latón niquelado y florón cromo

Incluye: manual de ducha anti-cal, soporte articulado en ABS y flexo metálico reforzado cromo

REF.11343112701 **110,00€**

EAN 8427 0000 36143

SERIE MONOMANDO

BEL AIR

- Cuerpo latón negro mate sistema lacado electrofóresis
- Cartucho cerámico 35mm normalizado
- Conexiones flexibles normalizadas AENOR
- Atomizador de latón
- Rosca de sujeción

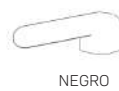

LAVABO ALTO NEGRO MATE

ACABADOS:

- Negro mate
REF. 11340212703 **130,00€**
EAN 8427 0000 37218

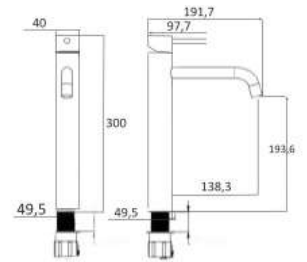

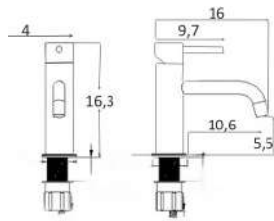

LAVABO NEGRO MATE

ACABADO

- Negro

REF.11340112703 **95,00€**

EAN 8427 0000 37171

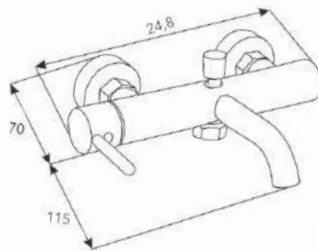

BAÑO DUCHA NEGRO MATE

Excéntricas con florón negro mate

Incluye: manual de ducha anti-cal, soporte articulado en ABS y flexo de PVC reforzado negro mate

ACABADO

- Negro

REF.11342112703 **149,00€**

EAN 8427 0000 36129

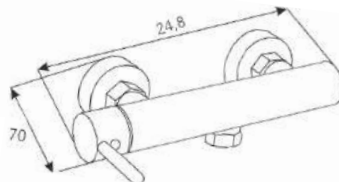

DUCHA NEGRO MATE

Excéntricas con florón negro mate

Incluye: manual de ducha anti-cal, soporte articulado en ABS y flexo de PVC reforzado negro mate

ACABADO

- Negro

REF.11343112703 **145,00€**

EAN 8427 0000 36150

SERIE MONOMANDO

BEL AIR

- Cuerpo latón oro mate cepillado sistema lacado electrofóresis
- Cartucho cerámico 35mm normalizado
- Conexiones flexibles normalizadas AENOR
- Atomizador de latón
- Rosca de sujeción



ORO CEPILLADO

SISTEMA LACADO
ELECTROFÓRESIS

LAVABO ALTO ORO MATE CEPILLADO

ACABADOS:

- Oro cepillado

REF. 11340212708 **155,00€**

EAN 8427 0000 37225

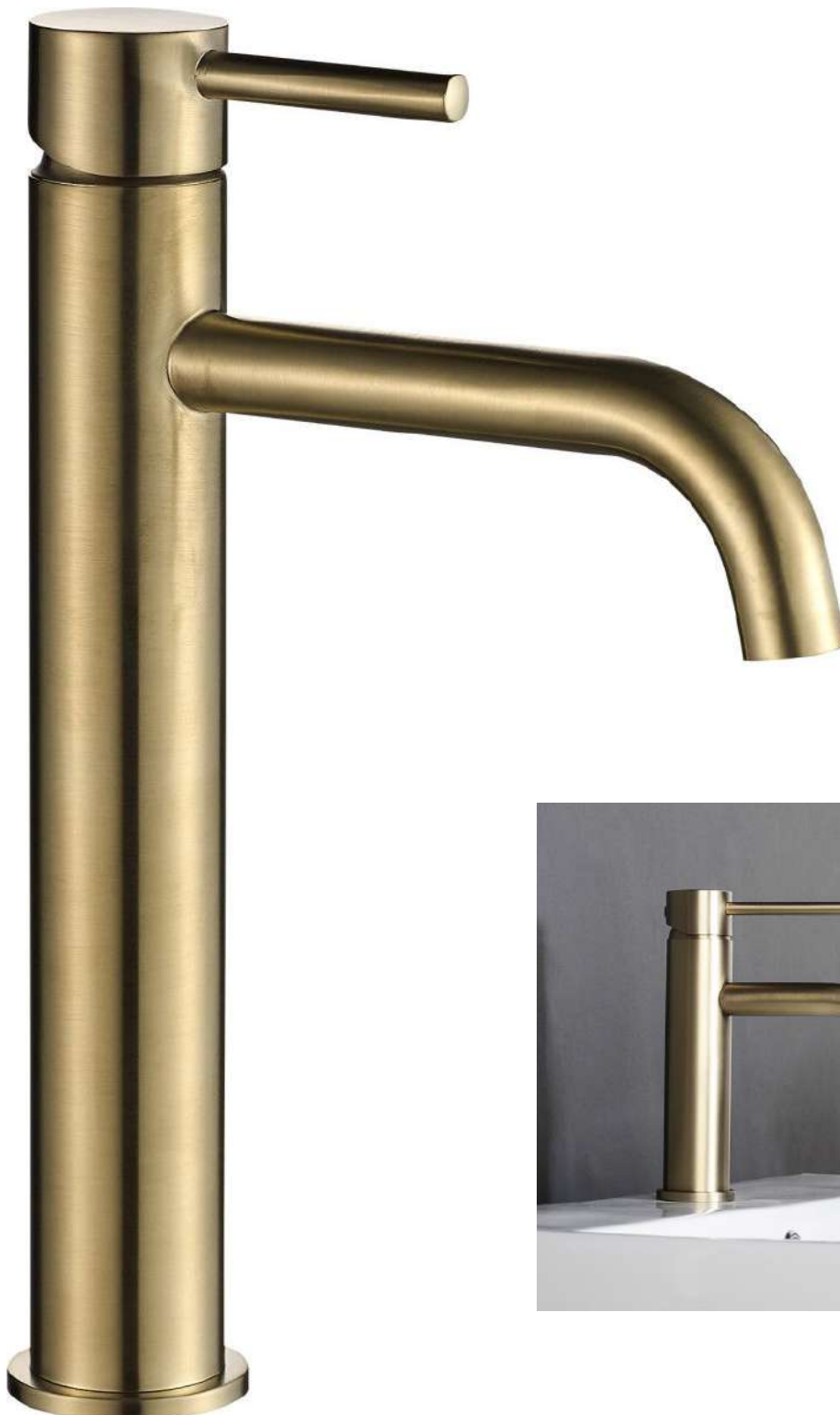
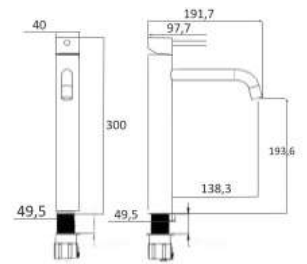

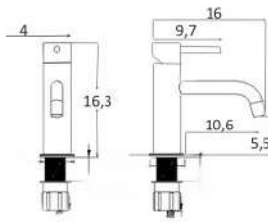

LAVABO ORO CEPILLADO

REF.11340112708 **125,50€**

EAN 8427 0000 37188

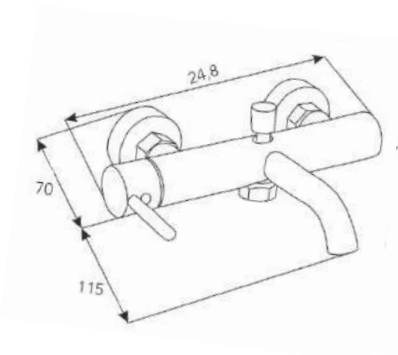

BAÑO DUCHA ORO CEPILLADO

Excéntricas con florón oro mate cepillado

Incluye: manual de ducha anti-cal, soporte articulado en ABS y flexo de PVC reforzado oro cepillado

ACABADO

- Oro mate
REF.11342112708 **199,00€**

EAN 8427 0000 36136

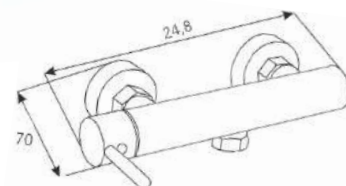

DUCHA ORO CEPILLADO

Excéntricas con florón oro mate cepillado

Incluye: manual de ducha anti-cal, soporte articulado en ABS y flexo de PVC reforzado oro cepillado

ACABADO

- Oro mate
REF.11343112708 **175,00€**

EAN 8427 0000 36167

SERIE MONOMANDO

BEL AIR

- Cuerpo y caño latón con embellecedor
- Cartucho cerámico 35mm normalizado antigoteo



LAVABO ENCASTRAR

ACABADOS:

- Cromo
REF. 12756112701 **105,00€**
- Negro mate
REF. 12756112703 **149,00€**
- Oro cepillado
REF. 12756112708 **175,00€**

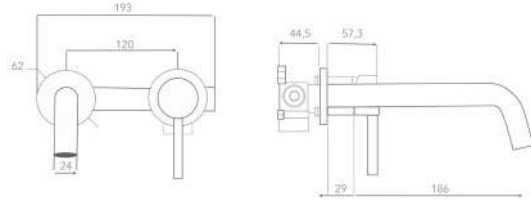

LAVABO ENCASTRAR CROMO

REF. 12756112701

EAN 8427 0000 08072



LAVABO ENCASTRAR NEGRO MATE

REF. 12756112703

EAN 8427 0000 37256



LAVABO ENCASTRAR ORO MATE

REF. 12756112708

EAN 8427 0000 37188

SERIE MONOMANDO

BEL AIR

DUCHA ENCASTRAR

ACABADOS:

- Cromo
REF. 12757112701 **245,00€**

- Negro mate
REF. 12757112703 **265,00€**

- Oro cepillado
REF. 12757112708 **295,00€**

- Cuerpo y caño latón con embellecedor
- Cartucho cerámico 35mm normalizado antigoteo
- Distribuidor de latón volante
- Mango de ducha
- Flexo de ducha PVC
- Soporte con toma de agua
- Brazo de ducha pared (opción a techo a consultar)
- Rociador redondo 20ø



DUCHA ENCASTRAR CROMO

REF. 12757112701

EAN 8427 0000 08089



DUCHA ENCASTRAR NEGRO MATE

REF. 12757112703

EAN 8427 0000 37294



DUCHA ENCASTRAR ORO CEPILLADO

REF. 12757112708

EAN 8427 0000 37300

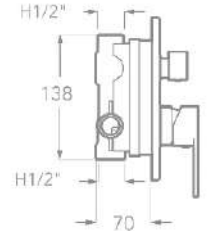
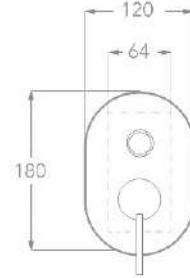

DUCHA ENCASTRAR TERMOSTÁTICA

BEL AIR

ACABADOS:

- Termostática empotrada
REF. 12757113701 **335,00€**

- Termostática empotrada 3 vías
REF. 12757113801 **375,00€**

- Cuerpo y caño acabado cromado
- Cartucho termostático
- Termostática de ducha empotrada
- Mezclador agua fría y caliente
- 2 salidas de agua



TERMOSTÁTICA ENCASTRAR 2 VÍAS

REF. 12757113701

EAN 8427 0000 3817

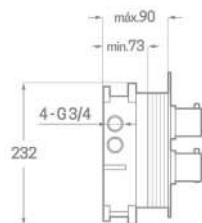
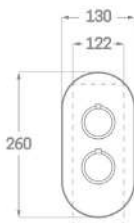

TERMOSTÁTICA ENCASTRAR 3 VÍAS

REF. 12757113801

EAN 8427 0000 3824

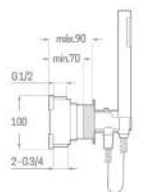
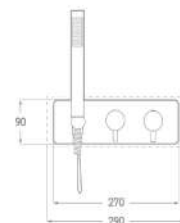



A close-up photograph of a white ceramic washbasin. The basin is oval-shaped with a smooth, glossy finish and sits on a light-colored wooden vanity. The background is a wall of white subway tiles with a black faucet visible on the left side.

MONOMANDO LAVABO ALTO NEW TWIST NEGRO

REF. 13240212703

SERIE MONOMANDO

NEW TWIST

LAVABO ALTO CROMO

MODELO:

- New Twist Cromo
REF. 13240212701 **125,00€**

EAN 8427 0000 03985

- Cuerpo latón cromado
- Cartucho cerámico 35mm normalizado
- Conexiones flexibles normalizadas AENOR
- Atomizador de latón
- Tornillo fijación de acero AISI 301

DISPONIBLE NOVIEMBRE 2022



CROMO

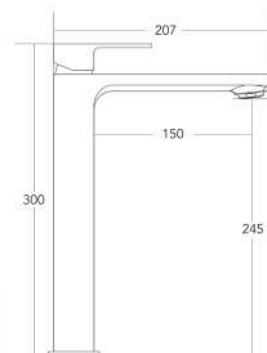

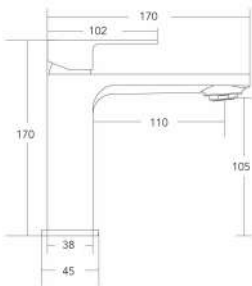

LAVABO CROMO

ACABADOS:

- New Twist Cromo
REF. 13240112701 **88,00€**

EAN 8427 0000 03992

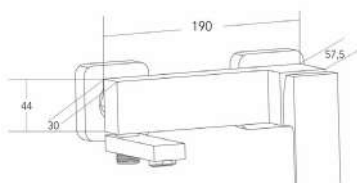
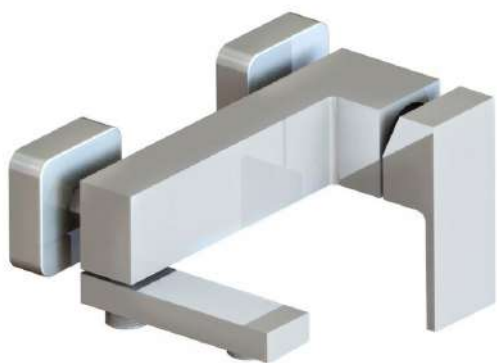

BAÑO DUCHA CROMO

Excéntricas latón niquelado y florón cromo

Incluye: manual de ducha antical, soporte articulado en ABS y flexo de metal reforzado

ACABADOS:

- New Twist Cromo
REF. 13242112701 **130,00€**

EAN 8427 0000 04913

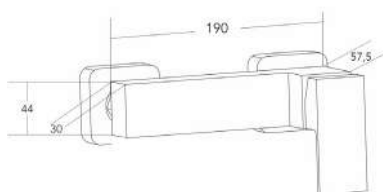
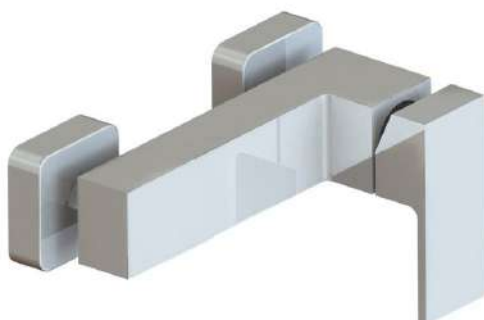

DUCHA CROMO

Excéntricas latón niquelado y florón cromado

Incluye: manual de ducha antical, soporte articulado en ABS y flexo de metal reforzado

ACABADOS:

- New Twist Cromo
REF. 13243112701 **105,00€**

EAN 8427 0000 04920

SERIE MONOMANDO

NEW TWIST

- Cuerpo latón sistema lacado electrofóresis
- Cartucho cerámico 35mm normalizado
- Conexiones flexibles normalizadas AENOR
- Atomizador de latón
- Tornillo fijación de acero AISI 301

DISPONIBLE NOVIEMBRE 2022



NEGRO



SISTEMA LACADO ELECTROFÓRESIS

LAVABO ALTO NEGRO MATE

ACABADOS:

- New Twist Negro
REF. 13240212703 **135,00€**

EAN 8427 0000 04930

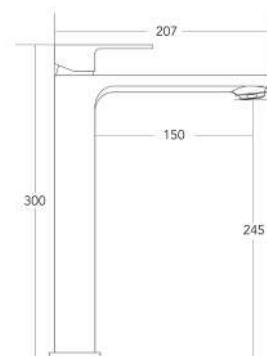

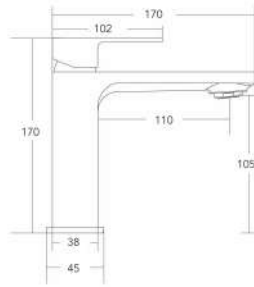

LAVABO NEGRO

ACABADOS:

- New Twist Negro
REF. 13240112703 **99,00€**

EAN 8427 0000 04944

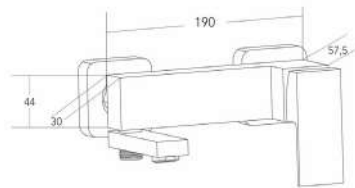
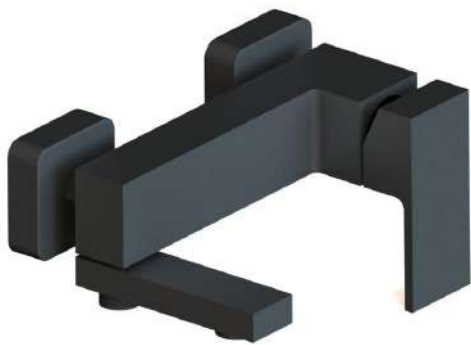

BAÑO DUCHA NEGRO

Excéntricas latón niquelado, con florón negro mate

Incluye: manual de ducha antical, soporte articulado en ABS y flexo de metal reforzado negro mate

ACABADOS:

- New Twist Negro
REF. 13242112703 **145,00€**

EAN 8427 0000 04968

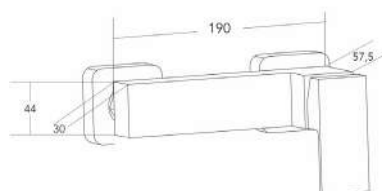

DUCHA NEGRO

Excéntricas latón niquelado, con florón negro mate

Incluye: manual de ducha antical, soporte articulado en ABS y flexo de metal reforzado negro mate

ACABADOS:

- New Twist Negro
REF. 13243112703 **125,00€**

EAN 8427 0000 04975

SERIE MONOMANDO

TWIST

- Cuerpo latón cromado
- Cartucho cerámico 35mm normalizado
- Conexiones flexibles normalizadas AENOR
- Atomizador de latón
- Tornillo fijación de acero AISI 301

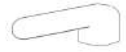

CROMO

LAVABO ALTO CROMO

MODELO:

- Twist Cromo 2021
REF. 13140212701 **115,00€**
EAN 8427 0000 06801

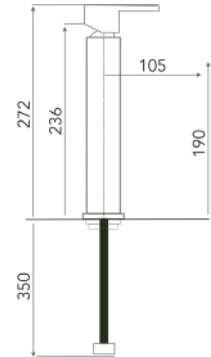

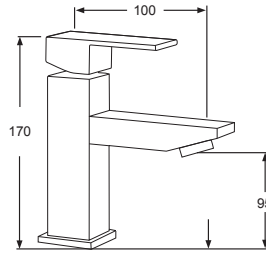

LAVABO CROMO

ACABADOS:

- Twist Cromo 2021
REF. 13140112701 **69,00€**

EAN 8427 0000 06825

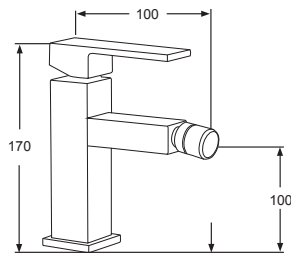

BIDÉ CROMO

ACABADOS:

- Twist Cromo 2021
REF. 13141112701 **69,00€**

EAN 8427 0000 06825

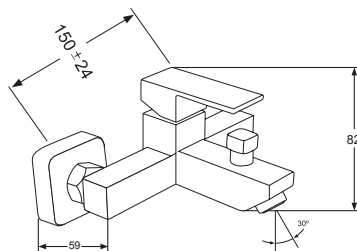

BAÑO DUCHA CROMO

Excéntricas latón niquelado y florón cromo

Incluye: manual de ducha antical, soporte articulado en ABS y flexo de metal reforzado cromo

ACABADOS:

- Twist Cromo 2021
REF. 13142112701 **110,00€**

EAN 8427 0000 06849

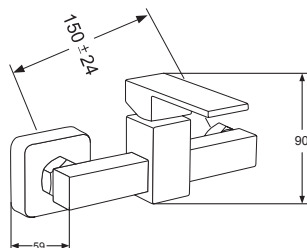

DUCHA CROMO

Excéntricas latón niquelado y florón cromado

Incluye: manual de ducha antical, soporte articulado en ABS y flexo de metal reforzado cromo

ACABADOS:

- Twist Cromo 2021
REF. 13143112701 **69,00€**

EAN 8427 0000 06856

SERIE MONOMANDO

TWIST

- Cuerpo y caño latón con embellecedor
- Cartucho cerámico 35mm normalizado antigoteo
- Box de registro



LAVABO ENCASTRAR REGISTRABLE

ACABADOS:

- Cromo
REF. 13155402701 **155,00€**

- Negro mate
REF. 13155402703 **175,50€**

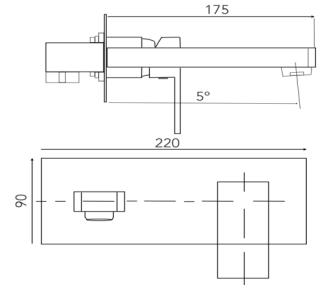

LAVABO ENCASTRAR REGISTRABLE CROMO

REF. 13155402701
EAN 8427 0000 37355

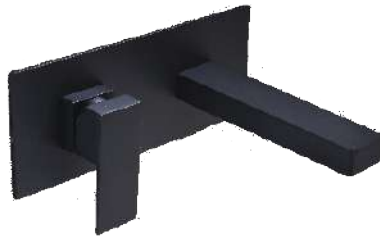

LAVABO ENCASTRAR REGISTRABLE NEGRO MATE

REF. 13155402703
EAN 8427 0000 37386



DUCHA ENCASTRAR

TWIST

ACABADOS:

- Cromo
REF. 13155112701 **285,00€**

- Negro mate
REF. 13155112703 **299,00€**

- Cuerpo latón con embellecedor
- Cartucho cerámico 35mm normalizado antigoteo
- Distribuidor de latón volante
- Mango de ducha
- Flexo de ducha
- Soporte con toma de agua
- Brazo de ducha pared (opción a techo a consultar)
- Rociador redondo 20ø



DUCHA ENCASTRAR MODELO TWIST CROMO 2 VÍAS

REF. 13155112701
EAN 8427 0000



DUCHA ENCASTRAR MODELO TWIST NEGRO 2 VÍAS

REF. 13155112703
EAN 8427 0000 37416

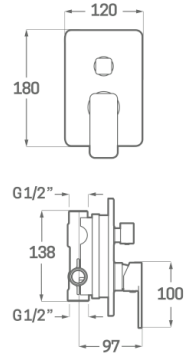

BAÑO ENCASTRAR

TWIST

ACABADOS:

- Cromo
REF. 13154112701 **375,00€**

- Negro mate
REF. 13154112703 **399,00€**

- Cuerpo y caños de latón con embellecedor
- Cartucho cerámico 35mm normalizado antigoteo
- Distribuidor de latón volante
- Mango de ducha
- Flexo de ducha
- Soporte con toma de agua
- Brazo de ducha pared (opción a techo a consultar)
- Rociador redondo 20ø



BAÑO ENCASTRAR CROMO 3 VÍAS

REF. 13154112701
EAN 8427 0000 37423

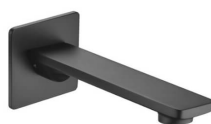

BAÑO ENCASTRAR NEGRO 3 VÍAS

REF. 13154112703
EAN 8427 0000 37461

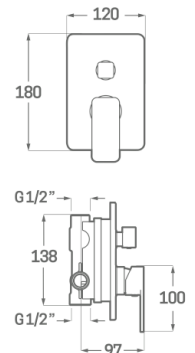

SERIE MONOMANDO

CASCADA

- Cuerpo latón cromado
- Cartucho cerámico 40 mm normalizado
- Conexiones flexibles normalizadas AENOR
- Tornillo fijación de acero AISI 301



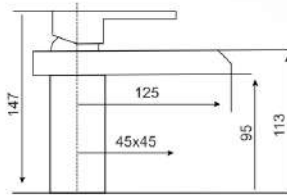

LAVABO CASCADA CENTRAL

ACABADOS:

- Cromo
REF. 11440112701 **148,50€**

EAN 8427 0000 06900

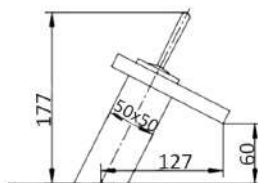

LAVABO CASCADA CENTRAL

ACABADOS:

- Cromo
REF. 11440112702 **105,60€**

EAN 8427 0000 06924

SERIE MONOMANDO

PARÍS

- Cuerpo latón cromado
- Cartucho cerámico 35mm normalizado
- Conexiones flexibles normalizadas AENOR
- Atomizador de latón
- Rosca de sujeción



CROMO

LAVABO ALTO CROMO

ACABADOS:

- Cromo

REF. 10240212701 **105,50€**

EAN 8427 0000 05958

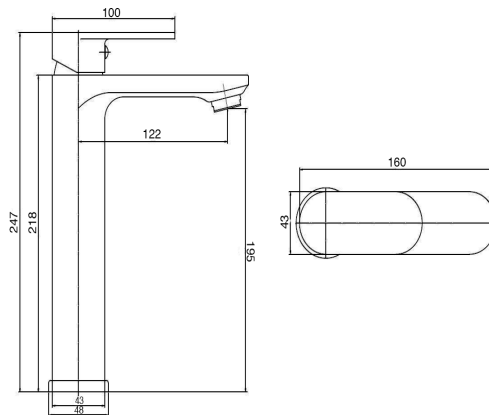

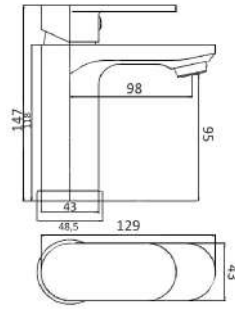

LAVABO CROMO

ACABADOS:

- Cromo

REF. 10240112701 **76,00€**

EAN 8427 0000 05903

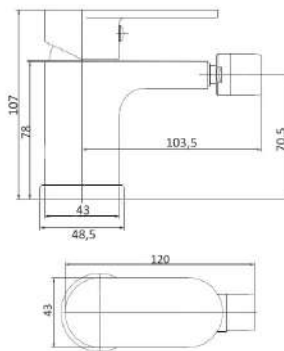

BIDÉ CROMO

ACABADOS:

- Cromo

REF. 10241112701 **76,00€**

EAN 8427 0000 05910

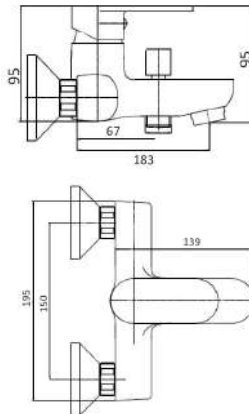

BAÑO CROMO

Excéntricas latón niquelado y florón cromo

Incluye: manual de ducha antical, soporte articulado en ABS y flexo de metal reforzado cromo

ACABADOS:

- Cromo

REF. 10242112701 **108,00€**

EAN 8427 0000 05927

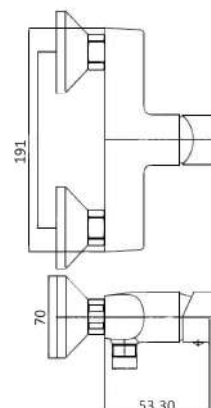

DUCHA CROMO

Excéntricas latón niquelado y florón cromo

Incluye: manual de ducha antical, soporte articulado en ABS y flexo de metal reforzado cromo

ACABADOS:

- Cromo

REF. 10243112701 **89,00€**

EAN 8427 0000 05934





MONOMANDO LAVABO CROMO MODELO MUNICH

REF. 10340112701

SERIE MONOMANDO

MUNICH

- Cuerpo latón cromado
- Cartucho cerámico 40mm normalizado
- Conexiones flexibles normalizadas AENOR
- Atomizador de latón
- Tornillo fijación de acero AISI 301



CROMO

LAVABO CROMO

ACABADOS:

- Cromo

REF. 10340112701 **59,00€**

EAN 8427 0000 05958

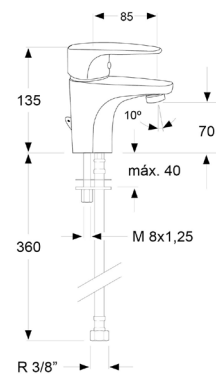

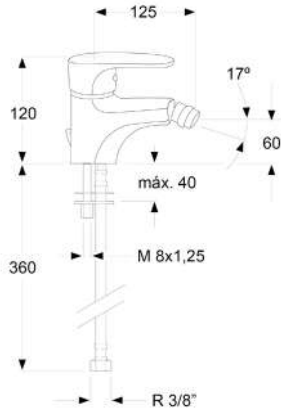

BIDÉ CROMO

ACABADOS:

- Cromo
REF. 10341112701 **59,00€**
EAN 8427 0000 05965

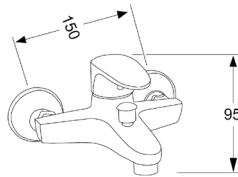
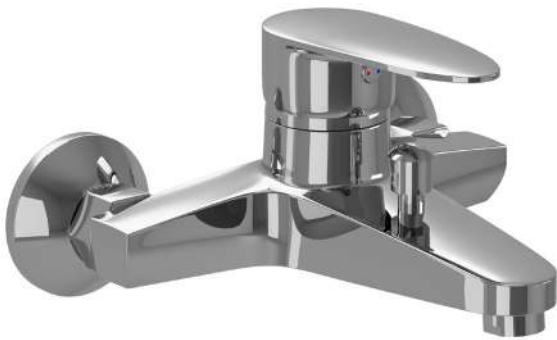

BAÑO DUCHA CROMO

Excéntricas latón niquelado y florón cromo

Incluye: manual de ducha antical, soporte articulado en ABS y flexo de metal reforzado cromo.

ACABADOS:

- Cromo
REF. 10342112701 **89,00€**
EAN 8427 0000 05972

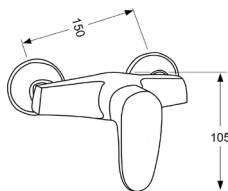
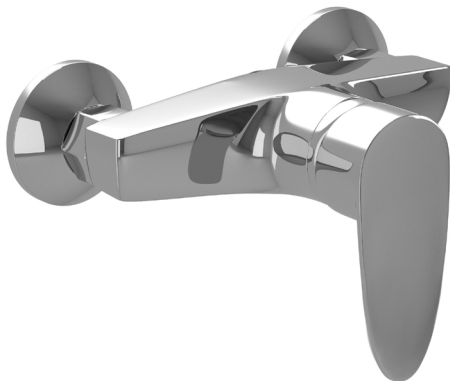

DUCHA CROMO

Excéntricas latón niquelado y florón cromo

Incluye: manual de ducha antical, soporte articulado en ABS y flexo de metal reforzado cromo

REF. 10343112701 **79,00€**
EAN 8427 0000 05989

SERIE MONOMANDO

LISBOA

- Cuerpo latón cromado
- Cartucho cerámico 35mm normalizado
- Conexiones flexibles normalizadas AENOR
- Atomizador de latón
- Tornillo fijación de acero AISI 301



CROMO

LAVABO CROMO

REF. 10140112701 **64,00€**

EAN 8427 0000 05804

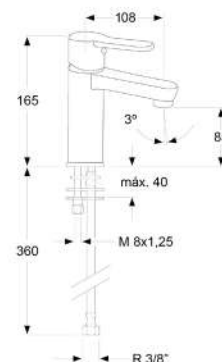

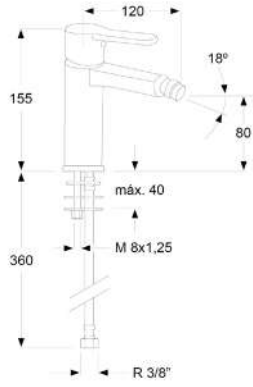

BIDÉ CROMO

REF. 10141112701 **64,00€**

EAN 8427 0000 05811

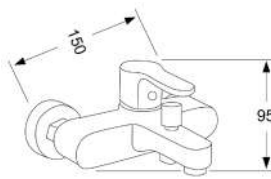

BAÑO DUCHA CROMO

Excéntricas latón niquelado y florón cromado

Incluye: manual de ducha antical, soporte articulado en ABS y flexo de metal reforzado cromo

REF. 10142112701 **96,00€**

EAN 8427 0000 05828

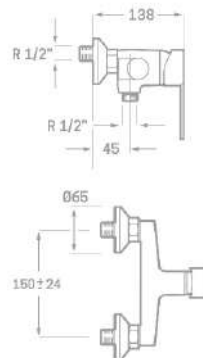
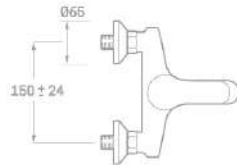

DUCHA CROMO

Excéntricas latón niquelado y florón cromado

Incluye: manual de ducha antical, soporte articulado en ABS y flexo de metal reforzado cromo

REF. 10143112701 **72,00€**

EAN 8427 0000 05835



MONOMANDO LAVABO LYON CROMO

REF. 11840112701



SERIE MONOMANDO

LYON

- Cuerpo latón cromado
- Cartucho cerámico 35mm normalizado
- Conexiones flexibles normalizadas AENOR
- Atomizador de latón
- Tornillo fijación de acero AISI 301



LAVABO CROMO

- Cromo

REF. 11840112701 **39,50€**

EAN 8427 0000 08409

- Maneta apertura en frío

REF. 11840112601 **48,00€**

EAN 8427 0000 08508

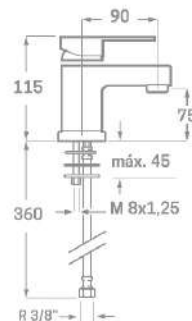

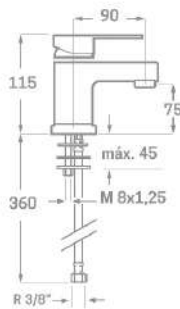

BIDE CROMO

REF. 11841112701 **39,50€**

EAN 8427 0000 08416

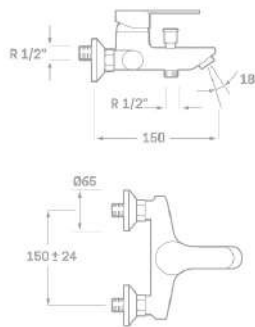

BAÑO DUCHA CROMO

Excéntricas latón niquelado y florón cromado

Incluye: manual de ducha antical, soporte articulado en ABS y flexo de metal reforzado cromo

REF. 11842112701 **55,00€**

EAN 8427 0000 08423

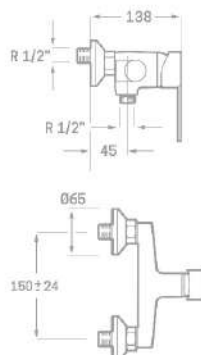

DUCHA CROMO

Excéntricas latón niquelado y florón cromado

Incluye: manual de ducha antical, soporte articulado en ABS y flexo de metal reforzado cromo

REF. 11843112701 **48,00€**

EAN 8427 0000 08430





MONOMANDO LAVABO SPRINTER CROMO

REF. 12040112701

SERIE MONOMANDO

SPRINTER

- Cuerpo latón cromado
- Cartucho cerámico 40mm normalizado
- Conexiones flexibles normalizadas AENOR
- Atomizador de latón
- Tornillo fijación de acero AISI 301



CROMO

LAVABO CROMO

REF. 12040112701 **38,50€**

EAN 8427 0000 06306

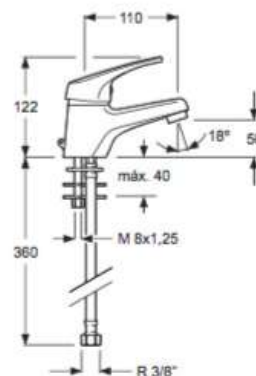

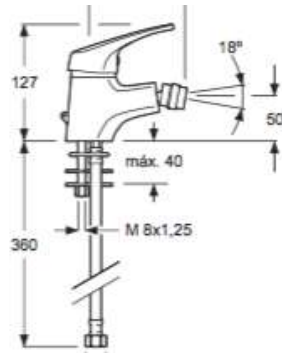

BIDE CROMO

REF. 12041112701 **38,50€**

EAN 8427 0000 06313

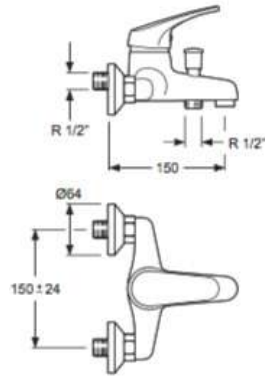

BAÑO DUCHA CROMO

Excéntricas latón niquelado y florón cromado

Incluye: manual de ducha antical, soporte articulado en ABS y flexo de metal reforzado cromo

REF. 12042112701 **57,50€**

EAN 8427 0000 06320

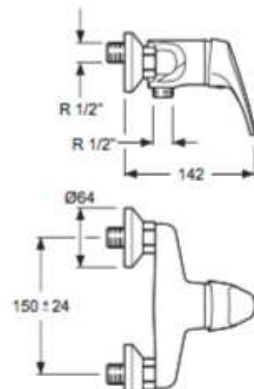
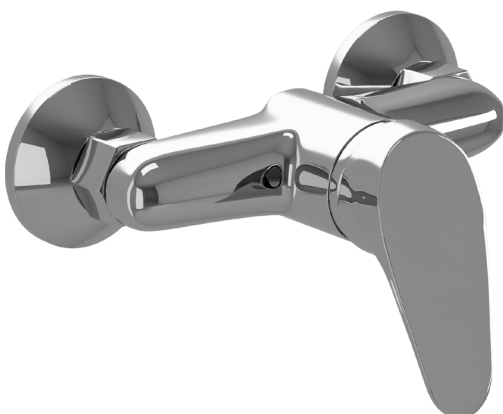

DUCHA CROMO

Excéntricas latón niquelado y florón cromado

Incluye: manual de ducha antical, soporte articulado en ABS y flexo de metal reforzado cromo

REF. 12043112701 **53,50€**

EAN 8427 0000 06337

SERIE MONOMANDO

CÁDIZ

- Cuerpo latón cromado
- Cartucho cerámico 40mm normalizado
- Conexiones flexibles normalizadas AENOR
- Atomizador de latón
- Tornillo fijación de acero AISI 301



CROMO

LAVABO CROMO

REF. 12240112701 **38,50€**

EAN 8427 0000 07303

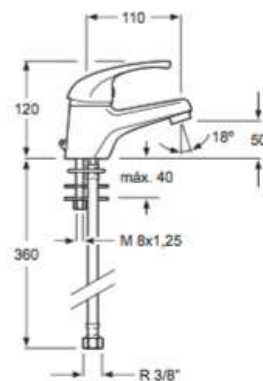

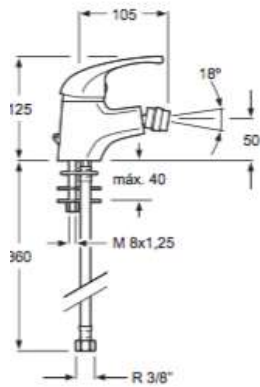

BIDE CROMO

REF. 12241112701 **38,50€**

EAN 8427 0000 07310

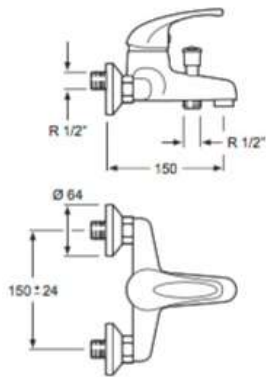

BAÑO DUCHA CROMO

Excéntricas latón niquelado y florón cromado

Incluye: manual de ducha antical, soporte articulado en ABS y flexo de metal reforzado cromo

REF. 12242112701 **57,50€**

EAN 8427 0000 07327

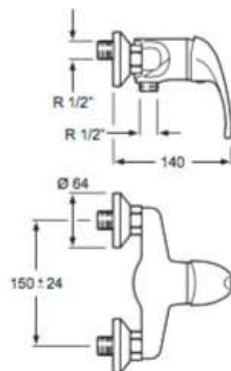

DUCHA CROMO

Excéntricas latón niquelado y florón cromado

Incluye: manual de ducha antical, soporte articulado en ABS y flexo de metal reforzado cromo

REF. 12243112701 **53,50€**

EAN 8427 0000 07334

SERIE MONOBLOC

ÉPOCA

- Cuerpo latón cromado
- Montura cerámica media vuelta
- Conexiones flexibles normalizadas AENOR
- Rótula y Atomizador cromado
- Tornillo fijación de acero AISI 301

LAVABO CROMO

REF. 14640212701 **105,50€**

EAN 8427 0000 03350

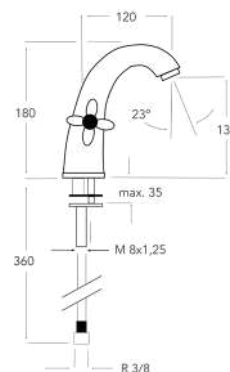



BIDE CROMO

REF. 14641212701 **105,50€**

EAN 8427 0000 05033

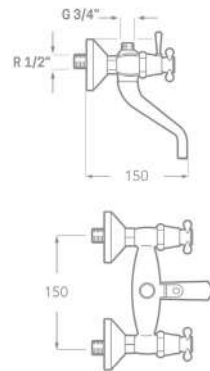

BAÑO CROMO

Excéntricas latón niquelado y florón cromado

Incluye: manual de ducha antical rectangular, soporte ABS clásico cromado, flexo de metal reforzado 1,7mts

REF. 14642212701 **176,00€**

EAN 8427 0000 05088

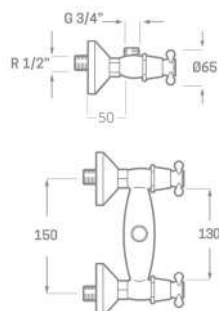

DUCHA CROMO

Excéntricas latón niquelado y florón cromado

Incluye: manual de ducha antical rectangular, soporte ABS clásico cromado, flexo de metal reforzado 1,7mts

REF. 14643212701 **105,50€**

EAN 8427 0000 05132

SERIE MONOBLOC

ÉPOCA

- Cuerpo latón envejecido
- Montura cerámica media vuelta
- Conexiones flexibles normalizadas AENOR
- Rótula y Atomizador de latón envejecido
- Tornillo fijación de acero AISI 301

LAVABO LATÓN ENVEJECIDO

REF. 14640212707 **105,50€**

EAN 8427 0000 03350

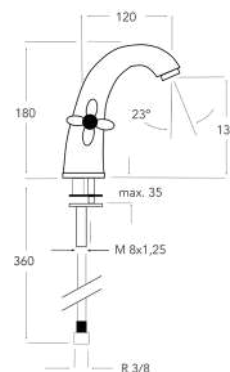



BIDE LATÓN ENVEJECIDO

REF. 14641212707 **105,50€**

EAN 8427 0000 09017

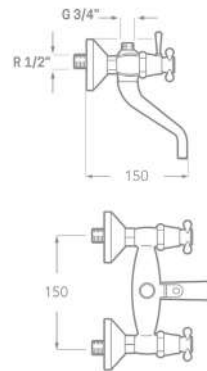

BAÑO LATÓN ENVEJECIDO

Excéntricas latón envejecido

Incluye: manual de ducha antical rectangular, soporte ABS clásico latón envejecido, flexo de latón envejecido reforzado 1,7mts

REF. 14642212707 **176,00€**

EAN 8427 0000 05224

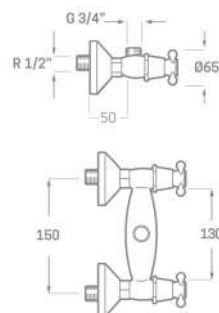

DUCHA LATÓN ENVEJECIDO

Excéntricas latón envejecido

Incluye: manual de ducha antical rectangular, soporte ABS clásico latón envejecido, flexo de latón envejecido reforzado 1,7mts

REF. 14643212707 **105,50€**

EAN 8427 0000 05217



GRIFO DE BAÑERA

EXENTA

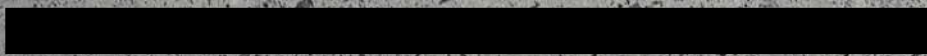



GRIFO BAÑERA EXENTA

BEL AIR

- Cuerpo de latón
- Cartucho cerámico 35mm normalizado antigoteo
- Distribuidor de baño ducha latón
- Incluye mango y flexo



ACABADOS:

- Cromo
REF. 11357112201 **450,00€**

- Negro mate
REF. 11357112203 **460,00€**



BEL AIR CROMO

REF. 11357112201
EAN 8427 0000 03893

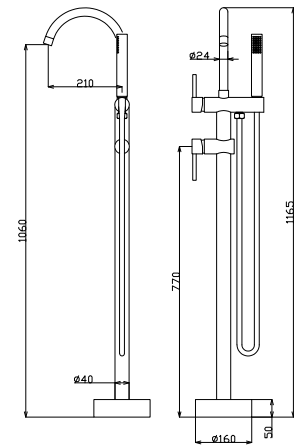

BEL AIR NEGRO MATE

REF. 11357112203
EAN 8427 0000 03909

GRIFO BAÑERA EXENTA

SQUARE

- Cuerpo de latón
- Cartucho cerámico 35mm normalizado antigoteo
- Distribuidor de baño ducha latón
- Incluye mango y flexo



ACABADOS:

- Cromo
REF. 11356112201 **450,00€**

- Negro mate
REF. 11356112203 **460,00€**



SQUARE CROMO

REF. 11356112201
EAN 8427 0000 03916



SQUARE NEGRO MATE

REF. 11356112203
EAN 8427 0000 03923

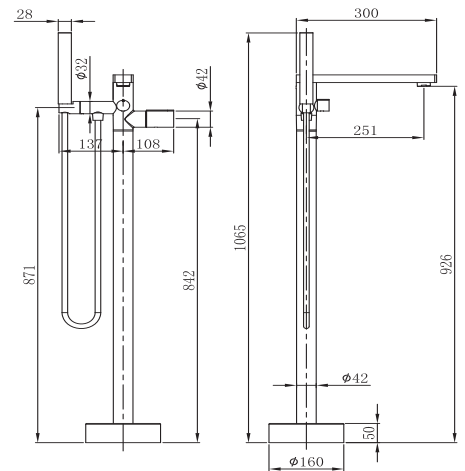

GRIFO BAÑERA EXENTA

CILINDRIC

- Cuerpo cromado de latón
- Cartucho cerámico 35mm normalizado antigoteo
- Distribuidor de baño ducha latón
- Incluye accesorios



ACABADOS:

- Cromo
REF. 11355112201 **475,00€**

- Negro mate
REF. 11355112203 **495,00€**



CILINDRIC CROMO

REF. 11355112201
EAN 8427 0000 03942



CILINDRIC NEGRO MATE

REF. 11355112203
EAN 8427 0000 03958

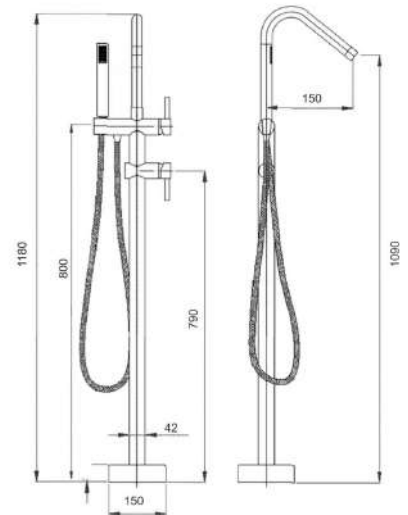

GRIFO BAÑERA EXENTA

CURVE

- Cuerpo cromado de latón
- Cartucho cerámico 35mm normalizado antigoteo
- Distribuidor de baño ducha latón
- Incluye accesorios



ACABADOS:

- Cromo
REF. 11354112201 **475,00€**

- Negro mate
REF. 11354112203 **495,00€**



CURVE CROMO

REF. 11354112201
EAN 8427 0000 03961



CURVE NEGRO MATE

REF. 11354112203
EAN 8427 0000 03978

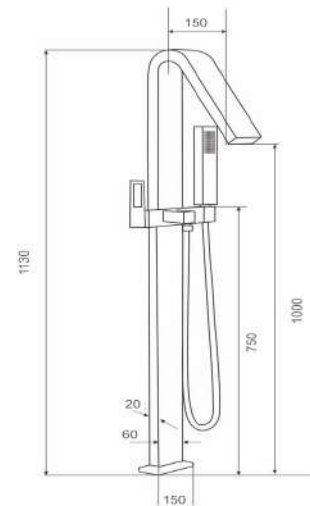

GRIFERIA DE COLUMNA

COLUMNA TERMOSTÁTICA SOFIA NEGRO MATE

REF. 580000013



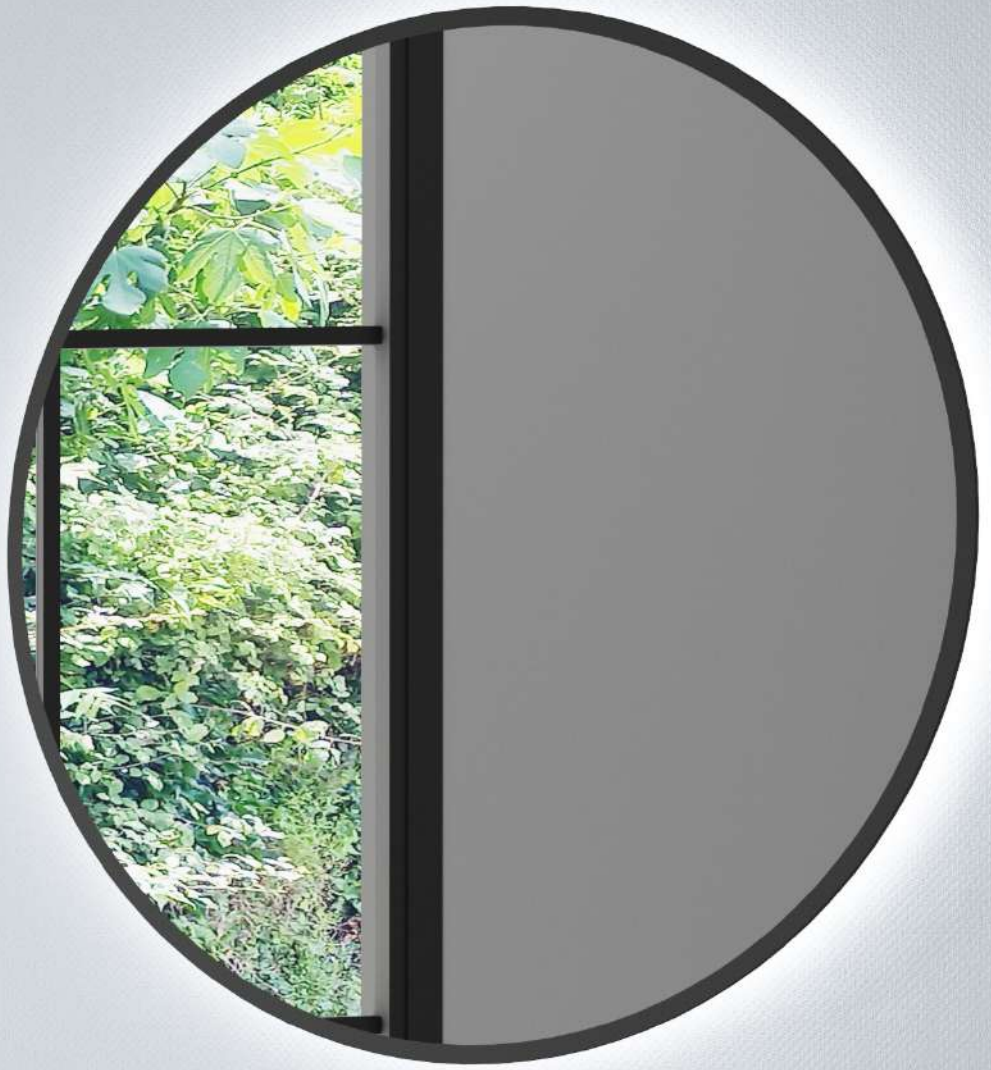

MONOMANDO LAVABO MODELO ALSACIA CROMO

REF. 11640112708



COLUMNA TERMOSTÁTICA

SOFIA

ACABADOS:

- Cromo

REF. 520000013 **260,00€**

EAN 8427 0000 05682

- Negro mate

REF. 530000013 **299,00€**

EAN 8427 0000 05439

- Blanco mate

REF. 530000014 **299,00€**

EAN 8427 0000 00544

- Barra extensible y soporte a pared de latón
- Rociador redondo Ø25cm membrana antical extraplano en acero inoxidable
- Flexo de ducha de acero reforzado con doble grapado de 170 cm.
- Manual de ducha con membrana antical
- Soporte manual de ducha deslizante
- Grifería termostática con mando de caudal y distribuidor en el mismo mando
- Presión máximo 6 at. Mínimo 1.5 at.
- Caudal medio 12 l/min.

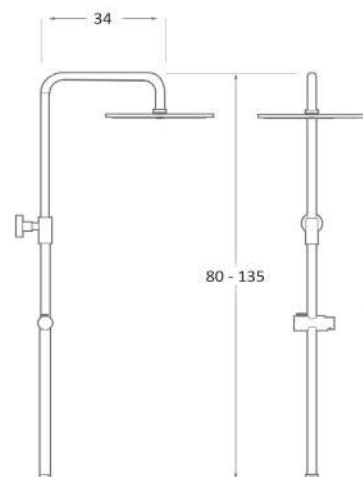



COLUMNA TERMOSTÁTICA MODELO SOFÍA BLANCO MATE

REF. 530000014

COLUMNA TERMOSTÁTICA

SUPREMA

ACABADOS:

- Cromo

REF. 520000014 **315,00€**

EAN 8427 0000 05644

- Negro mate

REF. 530000015 **330,00€**

EAN 8427 0000 04616

- Barra extensible y soporte a pared de latón
- Rociador cuadrado 25x25cm membrana antical extraplano en acero inoxidable
- Flexo de ducha de acero reforzado con doble grapado de 170 cm.
- Manual de ducha con membrana antical
- Soporte manual de ducha deslizante
- Grifería termostática con mando de caudal y distribuidor en el mismo mando
- Presión máximo 6 at. Mínimo 1.5 at.
- Caudal medio 12 l/min.

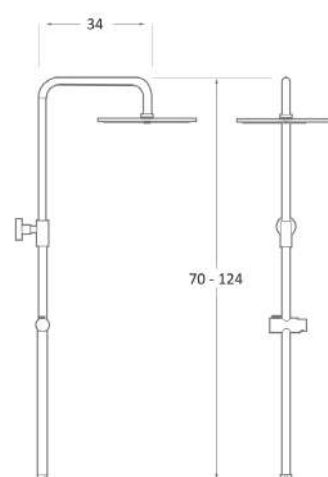
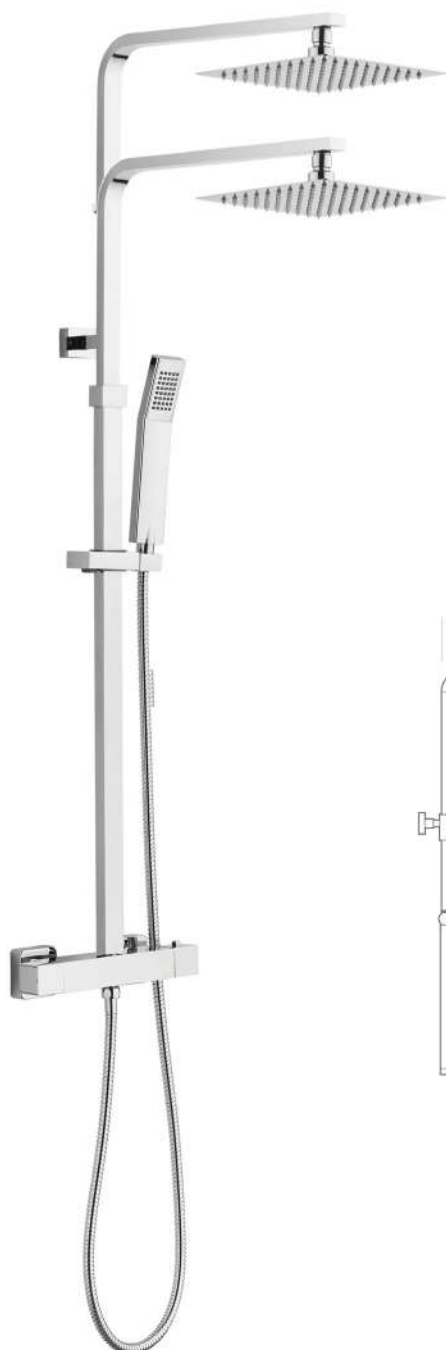



COLUMNA MONOMANDO

TWIST

ACABADOS:

- Cromo

REF. 520000016 **275,00€**

EAN 8427 0000 05545

- Negro mate

REF. 530000016 **299,00€**

EAN 8427 0000 04623

- Barra extensible y soporte a pared de latón
- Rociador cuadrado 25x25cm membrana antical extraplano en acero inoxidable
- Flexo de ducha de acero reforzado con doble grapado de 170 cm.
- Manual de ducha con membrana antical
- Soporte manual de ducha deslizante
- Grifería monomando con mando de caudal y distribuidor en el mismo mando
- Presión máximo 6 at. Mínimo 1.5 at.
- Caudal medio 12 l/min.

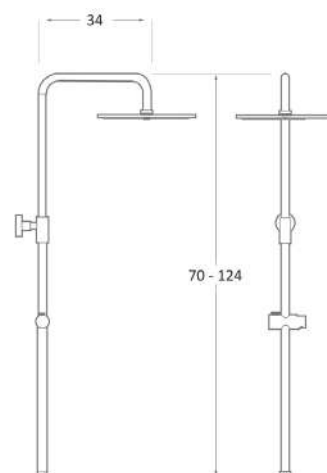
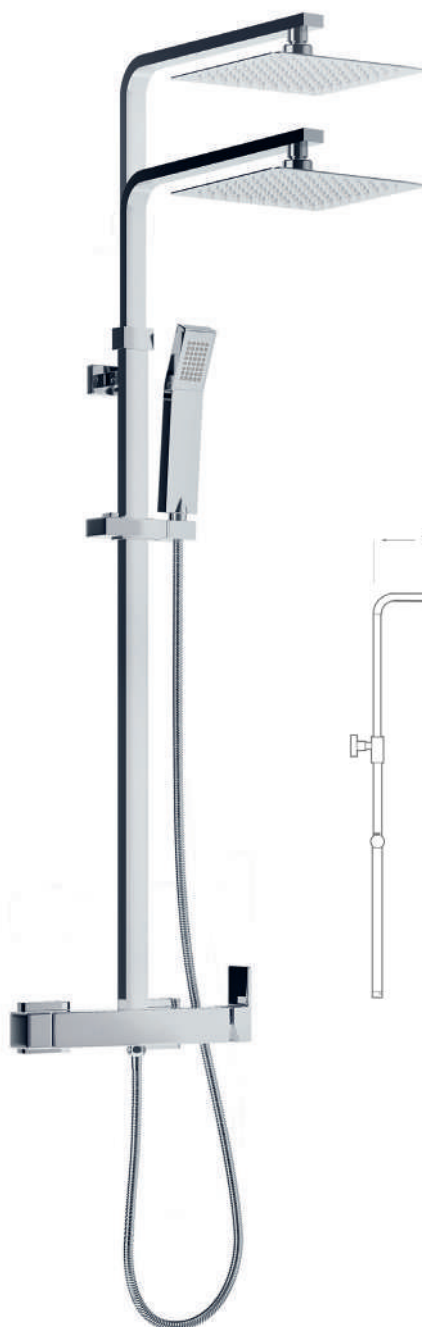

COLUMNA MONOMANDO

PALOS

ACABADOS:

- Ducha cromo

REF. 520000017 **280,00€**

EAN 8427 0000 05514

- Barra extensible y soporte a pared de latón cromo
- Rociador redondo Ø25cm membrana antical extraplano en acero inoxidable acabado cromo
- Flexo de ducha de acero reforzado con doble grapado de 170 cm.
- Manual de ducha con membrana antical
- Soporte manual de ducha deslizante
- Grifería monomando ducha modelo Palos
- Presión máximo 6 at. Mínimo 1.5 at.
- Caudal medio 12 l/min.

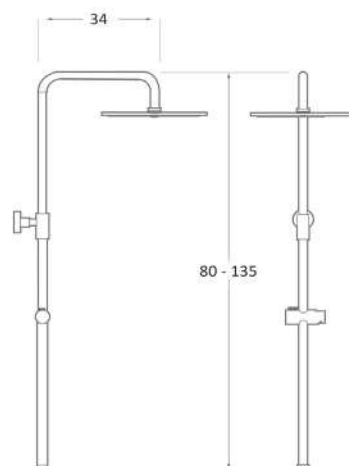

COLUMNA MONOMANDO

SELENA

ACABADO:

- Negro mate

REF. 530000012 **288,00€**

EAN 8427 0000 00544

- Barra extensible y soporte a pared de latón negro mate PVD
- Rociador redondo Ø25cm membrana antical extraplano en acero inoxidable negro mate PVD
- Flexo de ducha de acero reforzado con doble grapado de 170 cm. negro mate PVD
- Manual de ducha con membrana antical 3 posiciones negro mate PVD
- Soporte manual de ducha deslizante negro mate PVD
- Grifería monomando con distribuidor redondo negro mate PVD
- Presión máximo 6 at. Mínimo 1.5 at.
- Caudal medio 12 l/min.

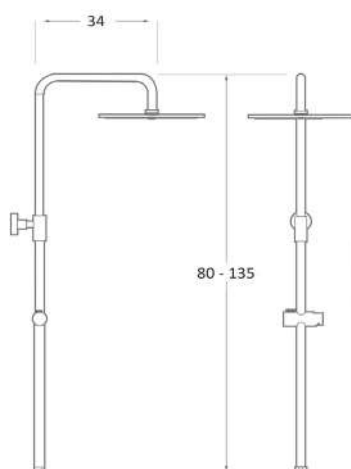

COLUMNA MONOMANDO

BORA BORA

ACABADOS:

- Cromo

REF. 520000020 **275,00€**

EAN 8427 0000 05569

- Oro mate cepillado

REF. 520000028 **315,00€**

EAN 8427 0000 05521

- Barra extensible y soporte a pared de latón
- Rociador redondo Ø25cm membrana antical extraplano en acero inoxidable acabado
- Flexo de ducha de acero reforzado con doble grapado de 170 cm.
- Manual de ducha con membrana antical
- Soporte manual de ducha deslizante
- Grifería monomando ducha modelo Bora Bora
- Presión máximo 6 at. Mínimo 1.5 at.
- Caudal medio 12 l/min.

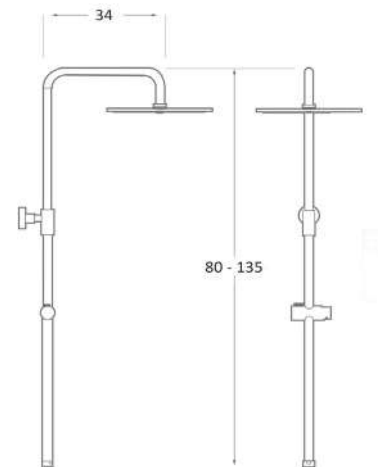

COLUMNA MONOMANDO

LYON

ACABADOS:

- Baño ducha cromo
REF. 510000019 **305,00€**

EAN 8427 0000 05651

- Prolongador repuesto 30cm
REF. 510000019 - 1 **18,00€**

- Ducha cromo
REF. 520000019 **210,00€**

EAN 8427 0000 05507

- Barra extensible y soporte a pared de latón cromo
- Rociador redondo Ø25cm membrana antical extraplano en acero inoxidable acabado cromo
- Flexo de ducha de acero reforzado con doble grapado de 170 cm.
- Manual de ducha con membrana antical
- Soporte manual de ducha deslizante
- Grifería monomando de baño con distribuidor integrado en la grifería y prolongador para bañera para modelo Lyon REF. 510000019
- Presión máximo 6 at. Mínimo 1.5 at.
- Caudal medio 12 l/min.

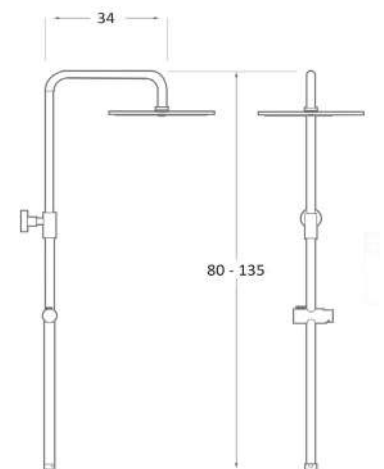
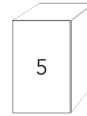

INCLUYE PROLONGADOR
30CM USO OPCIONAL



COLUMNA MONOMANDO

SPRINTER

ACABADOS:

- Ducha cromo

REF. 520000012 **210,00€**

EAN 8427 0000 05682

- Barra extensible y soporte a pared de latón cromo
- Rociador redondo Ø25cm membrana antical extraplano en acero inoxidable acabado cromo
- Flexo de ducha de acero reforzado con doble grapado de 170 cm.
- Manual de ducha con membrana antical
- Soporte manual de ducha deslizante
- Grifería monomando ducha modelo Sprinter
- Presión máximo 6 at. Mínimo 1.5 at.
- Caudal medio 12 l/min.

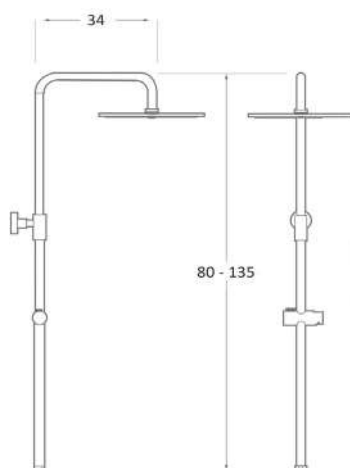
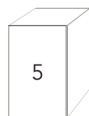

COLUMNA

VEJER

- Barra extensible y soporte a pared de latón
- Rociador redondo Ø25cm membrana antical extraplano en acero inoxidable acabado
- Flexo de ducha de acero reforzado con doble grapado de 170 cm.
- Manual de ducha con membrana antical
- Soporte manual de ducha deslizante
- Presión máximo 6 at. Mínimo 1.5 at.
- Caudal medio 12 l/min.

ACABADOS:

- Ducha cromo
REF. 52000011 **155,00€**

EAN 8427 0000 05675

- Ducha negro
REF. 53000011 **195,00€**

EAN 8427 0000 05668

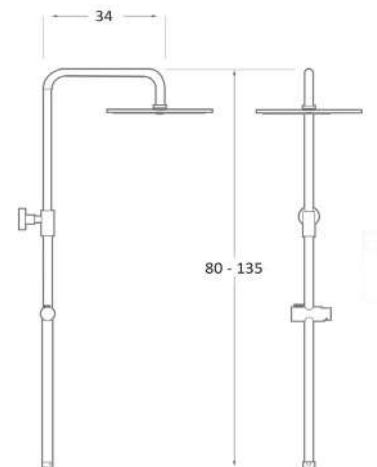
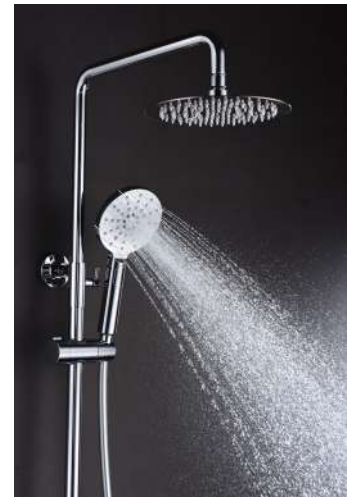
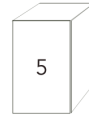

TERMOSTÁTICA

PICCOLO

- Cartucho termostática de latón y montura cerámica
- Regulación automática de la temperatura a 38°
- Incluye manual de ducha antical, flexo reforzado y soporte articulado.

ACABADOS:

- Baño cromo
REF. 20042122701 **136,50€**

- Ducha cromo
REF. 20043122701 **114,50€**

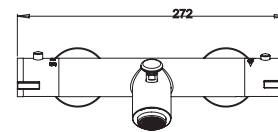
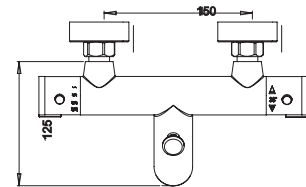

TERMOSTÁTICA DE BAÑO DUCHA MODELO PICCOLO CON ACCESORIOS

REF. 20042122701

EAN 8427 0000 02056

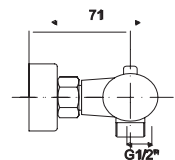
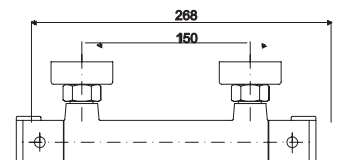
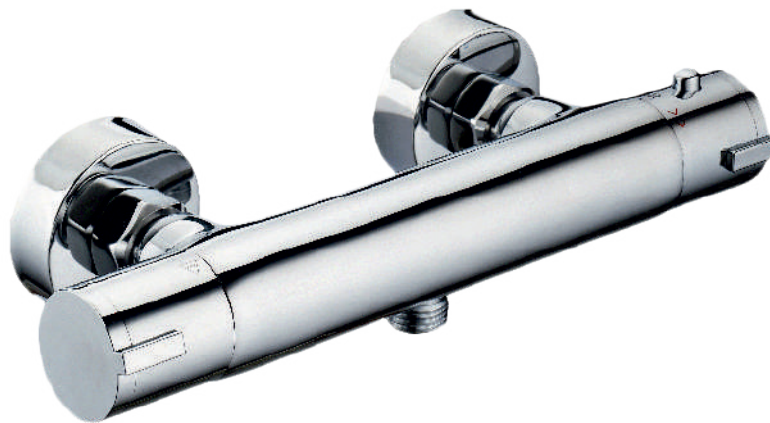

TERMOSTÁTICA DE DUCHA MODELO PICCOLO CON ACCESORIOS

REF. 20043122701

EAN 8427 0000 02070



BARRAS DE

DUCHA

- Barra deslizante hasta 60cms en aluminio con soportes y anclaje en ABS
- Flexo metálico 1.5m reforzado
- Mango de ducha de 4 posiciones
- *Modelo Nilo incluye jabonera



BARRA DESLIZANTE COMPLETA TIGRIS

ACABADOS:

- Cromo
REF. BR3750 **35,50€**
EAN 8427 0000 06597
- Negro
REF. BR3753 **45,00€**
EAN 8427 0000 06580
- Oro mate
REF. BR3758 **65,00€**
EAN 8427 0000 06573
- Oro rosa cepillado
REF. BR3759 **65,00€**
EAN 8427 0000 06566



*BARRA DESLIZANTE COMPLETA NILO

ACABADOS:

- Cromo
REF. BR3740 **39,00€**
EAN 8427 0000 06610



FLEXOS DE

DUCHA

FLEXOS:

- Cromo 1,7 - 2,20MTS
REF. 3400001 **6,50€**
EAN 8427 0000 00529
- Negro PVC 1,5 MTS
REF. 3400003 **14,50€**
EAN 8427 0000 37430

- Cromo: acero INOX304 doble engatillado reforzado
- Color: PVC
- Diametro extra grueso 15mmm
- Tubo interior EPFM
- Presión mac. 10BAR
- Temperatura max 80º



TOMAS DE AGUA



TOMAS DE AGUA Y SOPORTE CUADRADO



- Cuadrado cromo c/toma REF. 33100131 **15,50€**
EAN 8427 0000 01325
- Cuadrado negro c/toma REF. 33300131 **20,50€**
EAN 8427 0000 01325
- Soporte cuadrado cromo REF. 3300131 **8,80€**
EAN 8427 0000 01325
- Soporte cuadrado negro REF. 3300133 **8,80€**
EAN 8427 0000 01615

TOMAS DE AGUA Y SOPORTE REDONDO



- Redondo cromo c/toma REF. 331006 **24,50€**
EAN 8427 0000 01325
- Redondo negro c/toma REF. 333006 **28,50€**
EAN 8427 0000 01325
- Soporte redondo cromo REF. 3300006 **6,50€**
EAN 8427 0000 01325
- Soporte redondo negro REF. 3300003 **6,50€**
EAN 8427 0000 01622

BRAZOS DE

DUCHA



BRAZO PARED REDONDO 40CM

ACABADOS:

- Cromo

REF. 5302000140 **19,00€**

EAN 8427 0000 03534

- Negro

REF. 5302000340 **22,00€**

EAN 8427 0000 03841



BRAZO PARED CUADRADO 38CM

ACABADOS:

- Cromo

REF. 5302000138 **35,00€**

EAN 8427 0000 03565

- Negro

REF. 5302000338 **36,00€**

EAN 8427 0000 03572



BRAZO TECHO REDONDO 20CM

ACABADOS:

- Cromo

REF. 54000001 **20,0€**

EAN 8427 0000 03596

- Negro

REF. 54000003 **22,00€**

EAN 8427 0000 03602



BRAZO TECHO CUADRADO 20CM

ACABADOS:

- Cromo

REF. 54020001 **26,00€**

EAN 8427 0000 03626

- Negro

REF. 54020003 **28,00€**

EAN 8427 0000 03633



ROCIADORES

CUADRADOS

- Material: acero INOX304
- Extraplano
- Anti-calcáreo con economizador de agua con presión menor para su correcto funcionamiento.



ACABADOS:

- Cromo

20X20cm REF. RC52020
EAN 8427 0000 01301

32,50€

25X25cm REF. RC52025
EAN 8427 0000 01325

38,50€

30X30cm REF. RC52030
EAN 8427 0000 01332

42,50€

40X40cm REF. RC52040
EAN 8427 0000 01349

85,50€

- Negro

20X20cm REF. RC52020-3
EAN 8427 0000 01356

37,50€

25X25cm REF. RC52025-3
EAN 8427 0000 01363

45,50€

30X30cm REF. RC52030-3
EAN 8427 0000 01370

55,50€

ROCIADORES

REDONDOS



ACABADOS:

- Cromo

ø20cm REF. R52020
EAN 8427 0000 01110

29,50€

ø25cm REF. R52025
EAN 8427 0000 01127

37,50€

ø30cm REF. R52030
EAN 8427 0000 01134

44,50€

- Negro

ø20cm REF. R52020-3
EAN 8427 0000 01158

42,50€

ø25cm REF. R52025-3
EAN 8427 0000 01165

54,50€

ø30cm REF. R52030-3
EAN 8427 0000 01172

65,50€



MANGO DE DUCHA

ESPECIALES

- Mango de ducha en ABS, ergonómico y membrana antical
- 3 posiciones
- Incluye botón para cambio de posición



BLISTER
INDIVIDUAL



ACCESORIOS | 106

MANGO DUCHA MODELO SOHO 8CM

ACABADOS

- Cromo

REF. 40000010 **19,50€**

EAN 8427 0000 01479

- Negro mate

REF. 40000013 **22,50€**

EAN 8427 0000 01486

- Blanco mate

REF. 40000012 **22,50€**

EAN 8427 0000 01493



8cm

MANGO DUCHA MODELO MIAMI 8CM

ACABADOS

- Cromo

REF. 4000110 **21,50€**

EAN 8427 0000 01509

- Negro mate

REF. 4000113 **25,95€**

EAN 8427 0000 01516

- Blanco mate

REF. 4000112 **22,50€**

EAN 8427 0000 01523



12cm

MANGO DE DUCHA

BÁSICOS

- Membrana antical



BLISTER
INDIVIDUAL

1 POSICIÓN

Alcudia REF. 40000001 **11,50€**
EAN 8427 0000 01417

Tarraco REF. 40000003 **7,75€**
EAN 8427 0000 01431

Onda REF. 40000006 **8,15€**
EAN 8427 0000 01455

Square REF. 40000008 **8,80€**
EAN 8427 0000 01462

VARIAS POSICIONES

Reus REF. 40000005 **12,50€**
EAN 8427 0000 00120

Calpe REF. 40000002 **9,95€**
EAN 8427 0000 01448



MANGO MASAJE 1 POSICION ALCUDIA

REF. 40000001



10cm



MANGO MASAJE 1 POSICION TARRACO

REF. 40000003



9cm



MANGO MASAJE 5 POSICIONES REUS

REF. 40000005



10cm



MANGO MASAJE 1 POSICION ONDA

REF. 40000006



3,7cm



MANGO MASAJE 4 POSICIONES CALPE

REF. 40000002



7cm



MANGO MASAJE 1 POSICION SQUARE

REF. 40000008



6cm



GRIFOS DE BIDÉ

SUSTITUTIVOS

- Grifo empotrado fabricado en laton
- Mango de dos posiciones
- Flexo metal reforzado 1,2mts

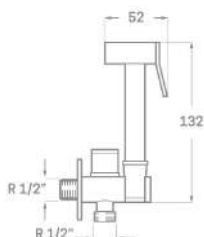

SUSTITUTIVO BIDÉ AGUA FRÍA

- Cromo
REF. 13130112701
EAN 8427 0000 04470

56,95€

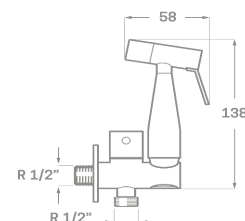

SUSTITUTIVO BIDÉ AGUA FRÍA

- Cromo
REF. 12730112701
EAN 8427 0000 04456

56,95€

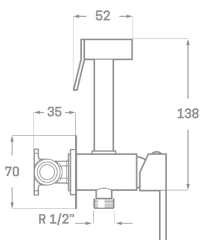

SUSTITUTIVO BIDÉ AGUA FRÍA Y CALIENTE

- Cromo
REF. 13130112702
EAN 8427 0000 04487

115,50€

- Negro
REF. 13130112705
EAN 8427 0000 04517

125,50€

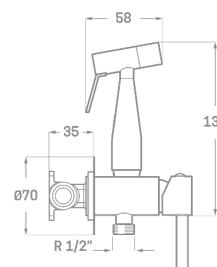

SUSTITUTIVO BIDÉ AGUA FRÍA Y CALIENTE

- Cromo
REF. 12730112702
EAN 8427 0000 04463

115,50€

- Negro
REF. 12730112705
EAN 8427 0000 04524

125,50€

GRIFOS DE BIDÉ WC

CON GRIFO

- Sustitutivo llave paso WC
Un agua.
Cierre 1/4 de vuelta.
Flexo reforzado 1,2 m.

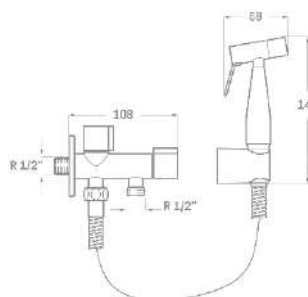

Ref. 12730112703
EAN 8427 0000 04630

75,00€

Ref. 12730112705
EAN 8427 0000 04685

85,00€

GRIFERÍA

TEMPORIZADA

- Cuerpo latón cromado
- Pulsador de latón
- Filtro de impurezas



MODELOS

- Temporizado urinario
REF. 19041112701 **40,00€**
- Temporizado mural 1 agua
REF. 19039112701 **47,00€**
- Temporizado mezclador
REF. 19040112703 **89,50€**
- Temporizado 1 agua
REF. 19040112701 **47,00€**
- Temporizado fuente vertical
REF. 19062112701 **42,00€**

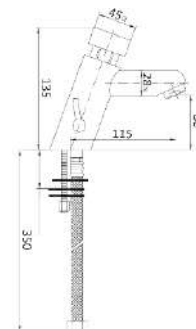

TEMPORIZADO MEZCLADOR AGUA FRÍA/CALIENTE

REF. 19040112703

EAN 8427 0000 11218

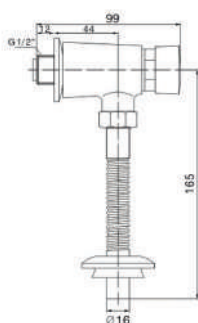

TEMPORIZADO URINARIO

Cartucho temporizado de latón
Entrada rosca macho 1/2"
Tubo de salida ajustable

REF. 19041112701

EAN 8427 0000 01172



TEMPORIZADO 1 AGUA

Entrada rosca macho 1/2"

REF. 19040112701

EAN 8427 0000 11157



TEMPORIZADO MURAL 1 AGUA

REF. 19039112701

EAN 8427 0000 11164



TEMPORIZADO FUENTE VERTICAL

Altura chorro agua 1,5 BAR = 6,8cm
Duración del caudal entre 8 y 12 seg.

REF. 19062112701

EAN 8427 0000 03442

GRIFERÍA DE PEDAL

- Acabado cromado
- Válvula de no retorno
- Instalación a suelo

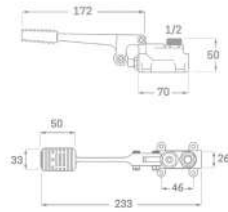

PEDAL A SUELO 1 AGUA

REF. 19040212701
EAN 8427 0000 11287

95,00€

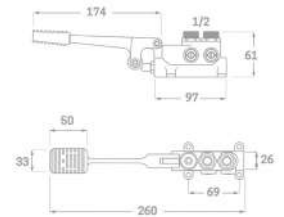

GRIFO 1 PEDAL SUELO MEZCLADOR

REF. 19046212701
EAN 8427 0000 11218

110,00€

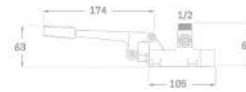

GRIFO 2 PEDALES A SUELO

REF. 19048212701
EAN 8427 0000 11270

150,00€

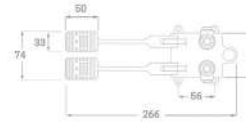

GRIFERÍA ELECTRÓNICA

- Cuerpo latón cromado
- Grifo agua fría.
- Sistema contactless con sensor infrarrojos.
- Distancia de detección regulable.



GRIFO ELECTRÓNICO LAVABO CON SENSOR AUTOMÁTICO PARA AGUA Y JABÓN

Fuente de alimentación corriente alterna AC/220V
Dispensador de jabón automático regulable (1500 ml)

REF. 19140112701
EAN 8427 0000 06641

190,00€

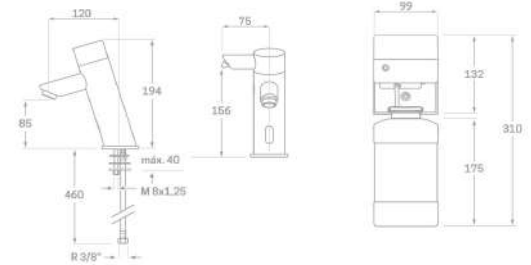

DISPENSADOR DE JABÓN
REGULABLE

GRIFO ELECTRÓNICO LAVABO CON SENSOR AUTOMÁTICO

- No necesita pilas
- Fuente corriente eléctrica
- autorecarga con la propia energía hidráulica

1 AGUA
REF. 19151112701
EAN 8427 0000 06634

175,00€

2 AGUAS
REF. 19151112702
EAN 8427 0000 06627

195,00€

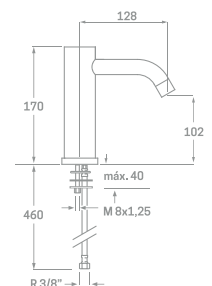

GRIFERIA DE COCINA

MONOMANDO FREGADERO CORFU CROMO

REF. 15259112501



MONOMANDO FREGADERO RODAS CROMO

REF. 12859112701



MONOMANDO FREGADERO MILÁN EXTRAIBLE CROMO

REF. 12759113205

MONOMANDO FREGADERO

CAMALEÓN

Cuerpo latón cromado

Cartucho cerámico de 35mm normalizado

Conexiones flexible normalizado AENOR

Caño giratorio

Rociador manual con dos posiciones (atomizador y lluvia)

Manguera con posibilidad de intercambiar por los diferentes colores

El tubo de goma que reviste el flexo es, por defecto, de color negro.

MODELOS:

- New Camaleón
REF. 12759112605 **185,00€**

- Camaleón color
REF. 12759112602 **185,00€**

- Muelle
REF. 12759112610 **199,00€**

- Manguera color **22,00€**



NEW CAMALEÓN

REF. 12759112605

EAN 8427 0000 08300

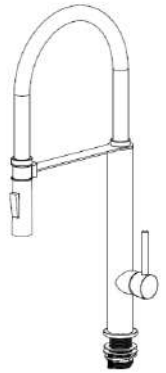
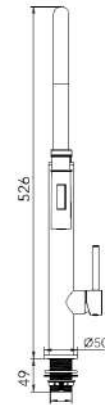
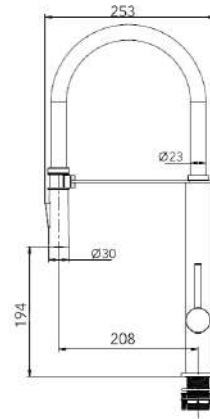

CAMALEÓN COLOR

REF. 12759112602

EAN 8427 0000 08287



CAMALEÓN MUELLE

REF. 12759112610

EAN 8427 0000 08294

MONOMANDO FREGADERO

MADAGASCAR

Cuerpo latón cromado
Cartucho cerámico de 35mm normalizado
Caño fundido giratorio tubo
Aireador anti-calcáreo
Conexiones flexibles normalizadas AENOR

ACABADOS:

- Cromo
REF. 15359112501 **146,00€**

- Acero cepillado
REF. 15359112515 **168,00€**

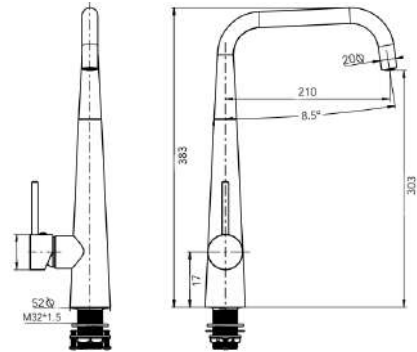

MADAGASCAR CROMO

REF. 15359112501

EAN 8427 0000 06320



MADAGASCAR ACERO CEPILLADO

REF. 15359112515

EAN 8427 0000 06337

MONOMANDO FREGADERO

MANILA

- Cromo
REF. 10459112201 **115,00€**
- Negro
REF. 10459112203 **120,00€**
- Oro cepillado
REF. 10459112208 **145,00€**

Cuerpo latón sistema lacado electrofóresis
Cartucho cerámico de 35mm normalizado
Conexiones flexibles normalizadas AENOR
Atomizador de latón
Tornillo fijación acero inox.
Caño tubo latón



DISPONIBLE NOVIEMBRE 2022



MANILA CROMO

REF. 10459112201

EAN 8427 0000 06689



MANILA NEGRO

REF. 10459112203

EAN 8427 0000 06696

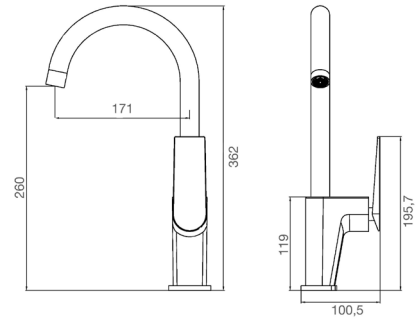

MANILA ORO CEPILLADO

REF. 10459112208

EAN 8427 0000 06658

MONOMANDO FREGADERO

CORFÚ

Cuerpo latón cromado
Cartucho cerámico de 35mm normalizado
Conexiones flexible normalizado AENOR
Caño fundido giratorio
Aireador anti-calcáreo

ACABADOS:

- Cromo
REF. 15259112501 **145,00€**

- Muelle extraíble
REF. 15259112601 **185,00€**



CORFU CROMO

REF. 15259112501

EAN 8427 0000 06306

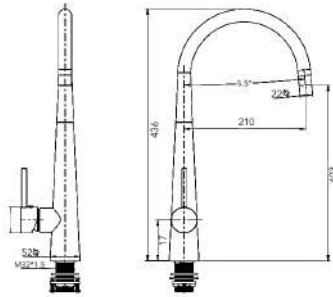

CORFU MUELLE CROMO

REF. 15259112501

EAN 8427 0000 06313

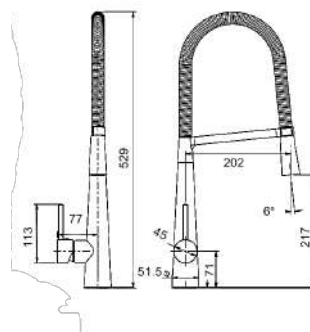



MONOMANDO FREGADERO

RODAS

- Cuerpo latón
- Cartucho cerámico de 35mm normalizado
- Conexiones Flexibles normalizadas AENOR
- Atomizador de latón
- Tornillo fijación AISI 301

ACABADOS:

- Cromo
REF. 12859112701 **62,00€**
- Acero cepillado
REF. 12859112705 **74,00€**
- Negro mate
REF. 12859112703 **74,00€**
- Blanco mate
REF. 12859112702 **74,00€**

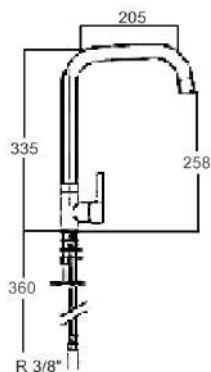

RODAS CROMO

REF. 12859112701
EAN 8427 0000 05880



RODAS ACERO CEPILLADO

REF. 12859112705
EAN 8427 0000 05897



RODAS NEGRO MATE

REF. 12859112703
EAN 8427 0000 05927



RODAS BLANCO MATE

REF. 12859112702
EAN 8427 0000 05910



MONOMANDO FREGADERO

CAÑO RECTO

- Cuerpo latón cromado
- Cartucho cerámico de 35mm normalizado
- Conexiones Flexibles normalizadas AENOR
- Atomizador de latón
- Caño fundido giratorio tubo
- Tornillo fijación AISI 301

MODELOS:

- Keops
REF. 15159112501 **140,00€**

- Cairo
REF. 15059112501 **225,00€**

- Ibiza
REF. 10659112501 **98,00€**

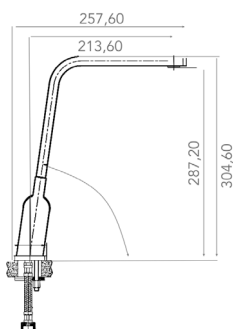

KEOPS CROMO

REF. 15159112701

EAN 8427 0000 05866



CAIRO CROMO

REF. 15059112515

EAN 8427 0000 05859



IBIZA CROMO

REF. 10659112501

EAN 8427 0000 05798

MONOMANDO FREGADERO

ABATIBLE

- Cuerpo latón cromado
- Cartucho cerámico de 35mm normalizado
- Conexiones Flexibles normalizadas AENOR
- Atomizador de latón
- Tornillo fijación AISI 301

ACABADOS:

- Abatible Florencia
REF. 27059112701

115,00€



ABATIBLE FLORENCIA

REF. 27059112701

EAN 8427 0000 01226

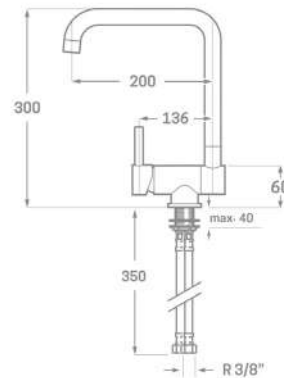

MONOMANDO FREGADERO

ÓSMOSIS

- Ósmosis Niza
REF.16059111701

138,00€

- Cuerpo latón cromado
- Cartucho cerámico de 35mm normalizado
- Conexiones Flexibles normalizadas AENOR
- Atomizador de latón
- Tornillo fijación AISI 301
- Caño latón fundido



ÓSMOSIS NIZA

REF. 16059111701

EAN 8427 0000 05724

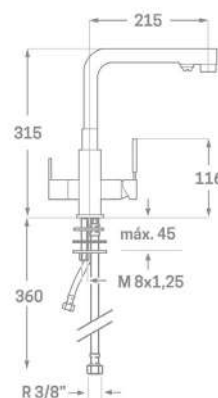

MONOMANDO FREGADERO

MILÁN

Cuerpo latón

Milán: Cartucho cerámico de 40mm normalizado

Extraíble: Cartucho cerámico de 35mm normalizado

Cartucho cerámico de 40mm normalizado

Conexiones flexibles certificado AENOR

Atomizador de latón

Tornillo fijación AISI 301

ACABADOS:

- Milán cromo
REF. 12759113201 **113,00€**

- Milán acero cepillado
REF.12759113105 **135,00€**

- Milán cromo extraíble
REF. 12759113202 **160,00€**

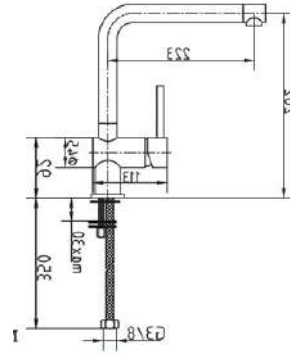

ANGULAR MILÁN CROMO

REF. 12759113201

EAN 8427 0000 01219



ANGULAR MILÁN ACERO CEPILLADO

REF. 12759113105

EAN 8427 0000 01356

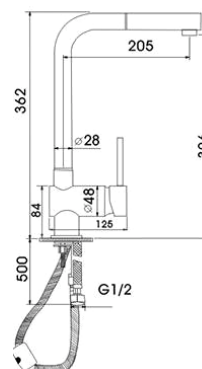

ANGULAR MILÁN EXTRAÍBLE CROMO

REF. 12759113202

EAN 8427 0000 01233





MONOMANDO FREGADERO

TOKYO HYBRID

- Cuerpo latón sistema lacado electrofóresis
- Cartucho cerámico de 35mm normalizado
- Conexiones flexibles AENOR
- Atomizador de latón
- Tornillo fijación de acero inox.
- Muelle de acero inoxidable

ACABADOS

- Cromo
REF. 13859112601 **350,00€**

- Oro rosa
REF. 13859112609 **370,00€**



MANUAL
ORIENTABLE

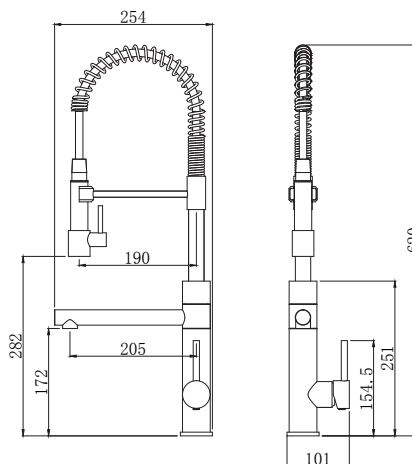

TOKYO HYBRID CROMO

REF. 13859112601
EAN 8427 0000 06665



TOKYO HYBRID ORO ROSA

REF. 13859112609
EAN 8427 0000 06672



MONOMANDO FREGADERO

TURÍN

- Cuerpo latón cromado
- Cartucho cerámico de 35mm normalizado
- Conexiones flexibles normalizadas AENOR
- Rociador orientable
- Rociador manual con dos posiciones (atomizador y lluvia)

- Muelle Turín
REF. 12759112601

145,00€



MUELLE ECO TURÍN

REF. 12759112601

EAN 8427 0000 08256

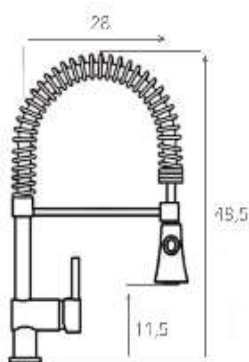

MONOMANDO FREGADERO

SIENA

- Siena
REF. 12759112401

175,00€

- Cuerpo latón cromado
- Cartucho cerámico de 35mm normalizado
- Conexiones flexibles normalizadas AENOR
- Atomizador de latón
- Tornillo fijación AISI 301
- Caño tubo 22
- Mango ducha extensible 2 posiciones en latón cromado

FREGADEROS | 128



CURVO EXTRAÍBLE SIENA

REF. 12759112401

EAN 8427 0000 03527

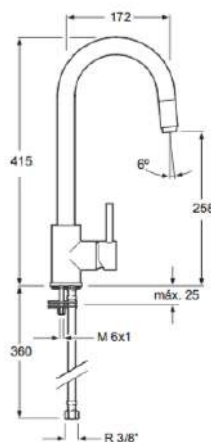

MONOMANDO FREGADERO

MADRID

- Cuerpo latón cromado
- Cartucho cerámico de 40mm normalizado
- Conexiones Flexibles normalizadas AENOR
- Atomizador de latón
- Tornillo fijación AISI 301

MODELOS:

- Madrid
REF.16059112301 **54,00€**

- Madrid Palos
REF.16059112201 **54,00€**



MADRID CROMO

REF. 16059112301
EAN 8427 0000 05866

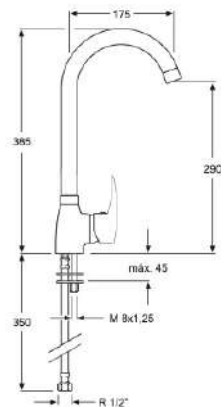

MADRID PALOS CROMO

REF. 16059112201
EAN 8427 0000 05866

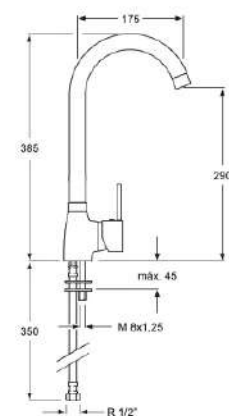

MONOMANDO FREGADERO

TWIST

- Cuerpo latón cromado
- Cartucho cerámico de 35mm normalizado
- Conexiones flexibles normalizadas AENOR
- Rociador orientable
- Rociador manual con dos posiciones (atomizador y lluvia)

MODELOS

- Twist angular square
REF. 13159112501

99,00€



TWIST ANGULAR SQUARE

REF. 13159112501
EAN 8427 0000 06870

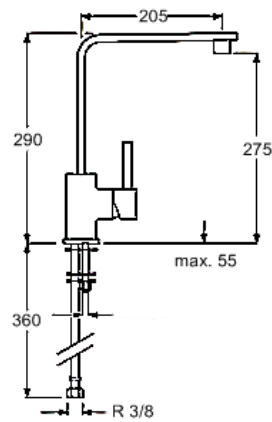

MONOMANDO FREGADERO

LISBOA

- Cuerpo latón cromado
- Cartucho cerámico de 35mm normalizado
- Atomizador de latón
- Tornillo fijación AISI 301

- Lisboa
REF.10159112501

68,00€



LISBOA CAÑO VERTICAL

REF. 10159112501
EAN 8427 0000 05842

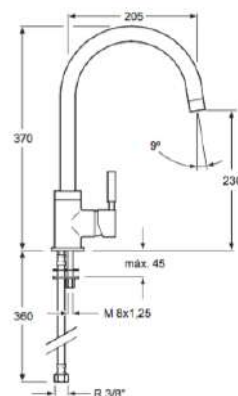

MONOMANDO FREGADERO

CÁDIZ

- Cuerpo latón cromado
- Cartucho cerámico de 40mm normalizado
- Conexiones flexibles normalizadas AENOR
- Atomizador de latón
- Tornillo fijación AISI 301
- Caño tubo latón fundido

MODELOS

- Vertical caño conformado
REF. 12259112501 **54,00€**

- Vertical caño fundido
REF. 12259112502 **75,00€**

- Caño horizontal
REF. 12259112401 **41,00€**



CAÑO HORIZONTAL CÁDIZ

REF. 12259112401
EAN 8427 0000 07341



CAÑO VERTICAL CÁDIZ

REF. 12259112501
EAN 8427 0000 07358

CAÑO VERTICAL CÁDIZ LATÓN FUNDIDO

REF. 12259112502
8427000007365

- Cuerpo latón cromado
- Cartucho cerámico de 40mm normalizado
- Conexiones flexibles AENOR
- Atomizador de latón
- Tornillo fijación de acero inox.
- Flexo y pesa
- Manual dos posiciones

MONOMANDO FREGADERO

CÁDIZ EXTRAÍBLE

MODELO

- Extraíble horizontal
REF. 12259112601 **67,00€**

- C/horizontal extraíble eco alto
REF. 16059111801 **99,00€**



CAÑO HORIZONTAL EXTRAÍBLE CÁDIZ

REF. 12259112601
EAN 8427 0000 07389



EXTRAÍBLE ECO ALTO CÁDIZ

REF. 16059111801
EAN 8427 0000 04081

FREGADERO MURAL

CÁDIZ

- Cuerpo latón cromado
- Cartucho cerámico de 40mm normalizado
- Conexiones flexibles AENOR
- Atomizador de latón
- Excéntricas de latón niquelado
- Caño tubo de latón 24ømm

MODELO

- Mural caño alto 15cm
REF. 12259112001 **63,00€**

- Mural caño alto 11cm
REF. 12259112002 **63,00€**

- Mural caño bajo 15cm
REF. 12259112101 **63,00€**

- Mural caño maneta clínica
REF. 12259112101 **72,00€**

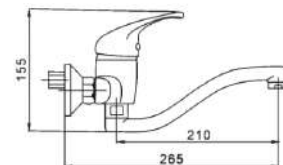

MURAL C/ BAJO 15CM CÁDIZ

REF. 12259112101

EAN 8427 0000 07372

MURAL C/ BAJO MANETA CLÍNICA CÁDIZ

REF. 12259112102

EAN 8427 0000 04494



MURAL C/ ALTO 15CM CÁDIZ

REF. 12259112001
EAN 8427 0000 04029

MURAL C/ ALTO 11CM CÁDIZ

REF. 12259112002
EAN 8427 0000 04036

FREGADERO MURAL

CÁDIZ

MODELO

- Lavabo maneta clínica
REF. 12240112702 **50,00€**

- Fregadero maneta clínica
REF. 12259112402 **48,00€**

- Cuerpo latón cromado
- Maneta clínica
- Cartucho cerámico de 40mm normalizado
- Conexiones flexibles AENOR
- Atomizador de latón
- Tornillo fijación de acero inox.

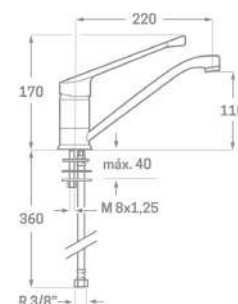

FREGADERO MANETA CLÍNICA

REF. 12259112402

EAN 8427 0000 07372



LAVABO MANETA CLÍNICA

REF. 12240112702
EAN 8427 0000 08386

GRIFERÍA MONOMANDO

1 AGUA

- Cuerpo latón cromado
- Cartucho cerámico de 25mm normalizado
- Atomizador de latón

MODELO

- Lavabo 1 agua encimera
REF. 12259112701 **29,50€**

- Fregadero 1 agua encimera
REF. 12259113001 **29,50€**

- Fregadero 1 agua mural
REF. 12259112801 **33,00€**



LAVABO 1 AGUA

REF. 12259112701
EAN 8427 0000 03411



FREGADERO 1 AGUA ENCIMERA C/ALTO

REF. 12259113001
EAN 8427 0000 45725



LAVABO 1 AGUA MURAL

REF. 12259112801
EAN 8427 0000 03404

GRIFERÍA MONOBLOC

1 AGUA

- Cuerpo latón cromado
- Entrada M1/2".
- Montura cierre cerámico

MODELO

- Grifo frontal office corto
REF. 14067112701 **18,00€**

- Fregadero 1 agua encimera c/alto
REF. 14060112701 **23,00€**

- Fregadero 1 agua mural c/ alto
REF. 14064112701 **21,00€**



GRIFO FRONTAL OFFICE CORTO

Longitud: 14 cm
REF. 14067112701
EAN 8427 0000 47156



FREGADERO 1 AGUA ENCIMERA C/ALTO

Caño giratorio Ø18mm filtro atomizador latón
Montura cierre cerámico

REF. 14060112701
EAN 8427 0000 42892



FREGADERO 1 AGUA MURAL C/ALTO

Longitud: 23 cm.
Montura cierre cerámico.

REF. 14064112701
EAN 8427 0000 42892

FREGADERO DE COCINA

MONOBLOC

- Cuerpo latón cromado
- Caño giratorio 18mm, longitud 23cm, con filtro atomizador
- Monturas cerámicas 1/2 vuelta
- Excéntricas latón niquelado
- Distancia entre eje de tomas 11 / 15cm
- Opción de sustituir por montura soleta

MODELO

- Mural 2 aguas 11cm
REF. 14065112701 **55,00€**

- Mural 2 aguas 15cm
REF. 14066112701 **55,00€**



MURAL 2 AGUAS 11CM

REF. 14065112701
EAN 8427 0000 04265

MURAL 2 AGUAS 15CM

REF. 14066112701
EAN 8427 0000 04289

DOSIFICADOR DE JABÓN

- Dosificador de plástico reforzado
- Dispensador fácil
- Bomba dispensadora jabón con cabezal flexible rotación de 360°

MODELO

- Dosificador redondo cromo
REF. 3115066 **27,00€**

- Dosificador redondo negro
REF. 3115063 **35,00€**

- Dosificador cuadrado cromo
REF. 3115070 **33,00€**

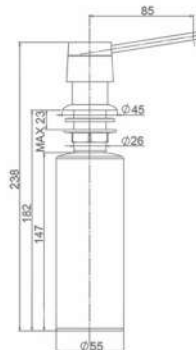

REDONDO CROMO

REF. 3115066
EAN 8427 0000 06740



REDONDO NEGRO

REF. 3115063
EAN 8427 0000 06757



CUADRADO CROMO

REF. 3115070
EAN 8427 0000 67338

Siente la frescura



VÁLVULAS

CLIC CLAC



LATÓN TAPÓN PEQUEÑO TORNILLO

- Cromo
REF. 000540 **15,50€**
EAN 8427 0000 10204



LATÓN TAPÓN SETA TORNILLO

- Cromo
REF. 000550 **20,50€**
EAN 8427 0000 10211



- Blanco mate
REF. 000552 **24,50€**
EAN 8427 0000 10181



- Negro mate
REF. 000553 **20,50€**
EAN 8427 0000 10198



- Oro cepillado
REF. 000447 **28,50€**
EAN 8427 0000 10105

- Oro rosa cepillado
REF. 000449 **28,50€**
EAN 8427 0000 01035



LATÓN TAPÓN CUADRADO TORNILLO

- Cromo
REF. 000560 **33,50€**
EAN 8427 0000 06757



LATÓN ECO C/ REBOSADERO

- Cromo
REF. 000440 **9,50€**
EAN 8427 0000 10150

- Negro
REF. 000443 **10,50€**
EAN 8427 0000 10150

- Oro cepillado
REF. 000448 **18,50€**
EAN 8427 0000 10150

LATÓN SETA C/REBOSADERO

- Cromo
REF. 000450 **11,50€**
EAN 8427 0000 10167

- Negro
REF. 000453 **12,50€**
EAN 8427 0000 01042



LATÓN CROMADO CUADRADO C/REB.

- Cromo
REF. 000460 **16,50€**
EAN 8427 0000 01059



SIFONES

VISTOS

- Material: latón
- 1"1/4 x ø32



ACABADOS:

- Cuadrado cromo
REF. 31141112702 **38,00€**
- Redondo cromo
REF. 31141112704 **30,00€**
- Redondo negro
REF. 31141112703 **32,00€**
- Redondo blanco
REF. 31141112705 **36,00€**
- Redondo oro cepillado
REF. 31141112708 **45,00€**



REDONDO LATÓN CROMO

REF. 31141112704
EAN 8427 0000 06719



REDONDO LATÓN ORO ROSA CEPILLADO

REF. 31141112709
EAN 8427 0000 06788



REDONDO LATÓN NEGRO

REF. 31141112703
EAN 8427 0000 67000



CUADRADO LATÓN CROMO

REF. 31141112702
EAN 8427 0000 06757



REDONDO LATÓN BLANCO

REF. 31141112705
EAN 8427 0000 06887



REDONDO LATÓN ORO CEPILLADO

REF. 31141112708
EAN 8427 0000 06757

ACCESORIOS COLECTIVIDADES

MOVILIDAD

- Acabado cromado
- Fabricado en acero inoxidable
- Incluye plafones y fijaciones fabricados en latón de alta calidad

MODELO

- Asa de seguridad baño ducha antideslizante
25cm

REF. 301026 **32,00€**

30cm

REF. 311030 **40,00€**

40cm

REF. 311040 **46,00€**

- Asa de baño angular 40cm

REF. 308111 **39,00€**

- Asa de baño angular 40cm con jabonera

REF. 308222 **48,00€**

-Barra de baño apoyo 77x77cm

Izquierdo

REF. 3082891 **135,00€**

Derecho

REF. 3082892 **135,00€**



BARRA DE BAÑO DE APOYO 770X770mm

Izquierdo

REF. 3082891

Derecho

REF. 3082891



ASA SEGURIDAD BAÑO DUCHA ANTIDESLIZANTE

25cm

REF. 301026

30cm

REF. 311030

40cm

REF. 311040



ASA DE BAÑO ANGULAR 40CM

Medida \varnothing 32

REF. 308111



ASA DE BAÑO ANGULAR CON JABONERA 40CM

Medida \varnothing 32

REF. 308222

MOVILIDAD

MODELO

- Asa abatible acero inoxidable

60cm
REF. 308600 **155,00€**

80cm
REF. 308800 **170,00€**

- Asa abatible c/portarrollos acero inoxidable

60cm
REF. 30860 **162,00€**

80cm
REF. 30880 **185,00€**

- Asiento de baño ABS
REF. 30828520 **110,00€**

- Asiento de baño con amortiguador ABS
REF. 30828530 **143,00€**



ASIENTO DE BAÑO PARED ABS

Material antideslizante
Capaz de soportar hasta 130 kg

REF. 30828520



ASA BAÑO ABATIBLE DUCHA ø32

Incluye sujeciones en latón de alta calidad

60cm
REF. 308600

80cm
REF. 308800



ASA BAÑO ABATIBLE C/ PORTARROLLOS ø32

Incluye sujeciones en latón de alta calidad

60cm
REF. 308601

80cm
REF. 308801



ASIENTO DE BAÑO PARED CON AMORTIGUADOR ABS

Amortiguador incorporado, lento, silencioso, duradero
Material antideslizante
Capaz de soportar hasta 130 kg

REF. 30828530

ACCESORIOS COLECTIVIDADES

JABONERAS

- Acabado cromado
- Fabricado en acero inoxidable

MODELO

- Jabonera 2 niveles triangular
REF. 60105 **73,50€**

- Jabonera de esquina
REF. 0008S **32,50€**

- Jabonera alargada 230x105x35
REF. 60115 **29,50€**

- Jabonera alargada ovalada
REF. 60125 **29,50€**

- Jabonera alargada asa interior 25x130x310
REF. TL017CR **49,50€**

- Jabonera alargada asa exterior 25x130x310
REF. TL018CR **49,50€**



JABONERA 2 NIVELES

Medida 245x350x60

REF. 60105



JABONERA ESQUINA

Medida 245x190x60

REF. 008S



JABONERA ALARGADA OVALADA

Medida 225x110x35

REF. 60125

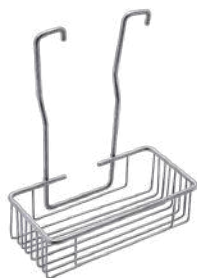

JABONERA ALARGADA RECTANGULAR ASA INTERIOR

Medida 25x130x310

REF. TL017CR

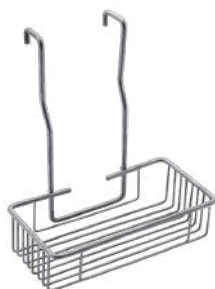

JABONERA ALARGADA RECTANGULAR ASA EXTERIOR

Medida 250x130x310

REF. TL018CR



JABONERA ALARGADA

Medida 230x105x35

REF. 60115

ACCESORIOS

COLECTIVIDADES

MODELO

- Toallero de mueble

Cromo 25cm

REF. 768125 **20,50€**

Cromo 35cm

REF. 768135 **22,50€**

Negro 35cm

REF. 76813505 **25,50€**

- Toallero recto a pared

Cromo

REF. 30402001 **39,00€**

Negro

REF. 30402003 **40,00€**

- Percha

Cromo

REF. 30501001 **24,00€**

Negro

REF. 30501003 **25,00€**

- Portarrollos moderno

Cromo

REF. 30401001 **26,00€**

Negro

REF. 30401003 **28,00€**

- Escobillero a suelo / pie

Cromo

REF. 30402001 **46,00€**

Negro

REF. 30402003 **49,00€**



ESCOBILLERO A SUELO/ PIE

Cromo

REF. 30402001

EAN 8427 0000 04962

Negro

REF. 30402003

EAN 8427 0000 04432

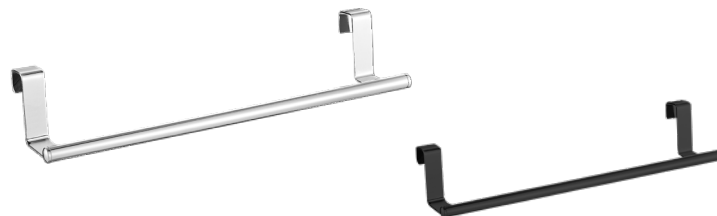

TOALLERO MUEBLE

Cromo 25cm

REF. 768125

EAN 8427 0000 04431

Cromo 35cm

REF. 768135

EAN 8427 0000 04403

Negro 38cm

REF. 76813505

EAN 8427 0000 4447



TOALLERO RECTO PARED

Cromo

REF. 30402001

EAN 8427 0000 04661

Negro

REF. 30402003

EAN 8427 0000 04425



PERCHA

Cromo

REF. 30501001

EAN 8427 0000 04678

Negro

REF. 30501003

EAN 8427 0000 04449



PORTARROLLOS MODERNO

Cromo

REF. 30401001

EAN 8427 0000 04708

Negro

REF. 30401003

EAN 8427 0000 04715

REPUESTOS

GRIFERÍA

MANGOS

- Manual fregadero extraíble
REF. 000402 **9,75€**

- Recambio manual muelle eco
REF. 23630SS **15,00€**

FLEXOS

- Extraíble cocina cromo
REF. 23614 **11,50€**

- Bidé WC íntimo
REF. 23290x **11,50€**

LLAVES DE ESCUADRA

- Llave palos montura cerámica 1/2" - 3/8"
REF. 00407 **7,50€**

- Llave palos montura cerámica 1/2" - 1/2"
REF. 00412 **10,50€**

- Llave twist montura cerámica 1/2" - 3/8"
REF. 00409 **10,00€**



MANUAL FREGADERO EXTRAÍBLE

REF. 000402



RECAMBIO MUELLE ECO/ CAMALEÓN

REF. 23630SS



FLEXO BIDÉ WC ÍNTIMO

REF. 23290



FLEXO DE EXTRAÍBLE COCINA

REF. 23614



LLAVE PALOS MONTURA CERÁMICA

REF. 00407
REF. 00412



LLAVE TWIST MONTURA CERÁMICA

REF. 00409

Condiciones generales y garantías

General Conditions and warranties



CONDICIONES GENERALES

CONDICIONES GENERALES DE VENTA

La recepción de un pedido indica por parte del Comprador la aceptación de las presentes Condiciones Generales de Venta, salvo acuerdo particular y escrito entre ambos.

DISEÑO

Nuestros modelos PUEDEN SER MODIFICADOS sin previo aviso, por exigencia de diseño, siempre en beneficio del artículo.

PRECIOS

Los precios de la tarifa son PVP. Los precios válidos son los de la TARIFA VIGENTE en el momento de la facturación.

ENTREGAS

Las expediciones por importe inferior a 250 € serán a portes debidos (10 €). Nuestros productos se consideran siempre vendidos en nuestros almacenes. Las mercancías se expiden y viajan únicamente por cuenta y riesgo del destinatario, quien comprobará al recibo de la mercancía el estado de la misma, indicando las posibles anomalías en el albarán del transportista. En ningún caso se suministrarán pedidos que no sean de faltas u originados por nosotros inferiores a 150 €.

TRANSPORTE

Las incidencias producidas por transporte deben comunicarse en un máximo de 24 h una vez recibida la mercancía.

Reclamaciones posteriores a este plazo NO SERÁN ADMITIDAS.

ENTREGAS URGENTES

El comprador pagará el transporte especial.

APLICACIÓN IVA

En los precios indicados en esta tarifa NO ESTÁ INCLUIDO EL IVA.

IMPAGADOS

El incumplimiento por parte del comprador de las condiciones de pago previamente acordadas, significa por parte del vendedor la retención de los pedidos pendientes de entrega, hasta la total solución del descubierto producido. (Gastos ocasionados y financiación) Los impagados no resueltos en un plazo máximo de 30 días serán comunicados a la compañía de seguros Crédito y Caución con la que trabajamos.

DEVOLUCIONES

No se admitirá ninguna devolución de material que no haya sido pactada por nuestro delegado y/o autorizada por nuestra dirección comercial. Para cualquier devolución se definirán con claridad los motivos de la misma, teniendo en cuenta las siguientes condiciones:

1. No se admitirá ningún material que, tanto en modelo como en acabado, esté fuera del catálogo.
 2. El material que esté en perfecto estado, incluso en embalaje, será abonado con un 15% de descuento en concepto de gastos de recepción, revisión y manipulación.
 3. Si el material tiene algún desperfecto no imputable a nuestra fabricación, no se admitirá devolución, pero puede arreglar se con cargo si el defecto es reparable.
 4. No se aceptará ninguna devolución que no se ajuste a lo especificado.
-

CONDICIONES DE PAGO

1. Todas las operaciones serán ASEGURADAS por la compañía Crédito y Caución, y dependiendo de su valoración el pedido será efectuado. En caso de que la misma no asegure la venta, estos mismos se producirán mediante pago por adelantado.
2. En pedidos inferiores a 300€ el pago no excederá a pago 30 días fecha factura.
3. Las facturas han de ser abonadas por cheque o recibo bancario domiciliado. Los pagos contado serán liquidados mediante recibo bancario a 15 días fecha factura, pagaré o confirming.
4. No se admitirá el fraccionamiento del pago de facturas inferiores a 600€.
5. Los gastos ocasionados por impago de facturas o retraso de fechas establecidas, serán por cuenta del comprador.
6. Los gastos ocasionados por impago de facturas o retraso de fechas fijadas, serán por cuenta del comprador.

GENERAL TERMS

GENERAL TERMS OF SALE

The reception of an order implies the acceptance of the following general terms of sale from the purchaser, except in case of written agreement the contrary between both of them.

DESIGN

Our models can be modified without previous notice on request of design and always for article again.

PRICES

Prices on the present list are Final Consumer Prices. The valid prices are those of the Price list in force at the moment of the invoicing.

DELIVERIES

All consignments of less than 350€ will be sent carriage forward. We always consider our products as sold Ex Works. Goods are shipped purchasers expense and risk and the buyer will check the state of the consignment on reception of the shipment pointing out damages in the delivery note and giving it to the carrier.

URGENT DELIVERIES

Special transport expenses will be on the purchaser.

VAT

Prices on list do not include VAT.

FAILURE TO PAY

If purchaser fails to make payment as agreed, seller shall hold outstanding deliveries until the complete settlement of the amount due. Non-payments not resolved within a maximum period of 30 days will be communicated to the insurance company "Crédito y Caución" with which we work.

RETURNS

No return will be accepted, except those agreed with our representative or authorized by our marketing department. The reason for return should be specified in any particular case, following the conditions below:

1. No returns will be accepted, except those agreed with pure representative and/or authorized by our marketing department.
 2. No goods out of catalogue will be accepted.
 3. If goods are in perfect conditions including packaging will make the refund with a 15% of discount for checking and handling expenses.
 4. If the material shows a defect that's not attributable to our manufacturing process, no refunds will be given. However, we'll repair the product or charge.
 5. There will be no acceptance of return in accordance of these conditions.
-

PAYMENTS

Invoices will be settled by or Swift transfer at maximum 60 days from invoice date. Payments agreed for a longer term will incur a financial charge. Swift transfer will settle cash payment at 15 days from invoice date. In case of delay, including those caused by holidays, the buyer shall settle any expenses.

GARANTÍAS

Nuestros productos están garantizados por 5 años a partir de la fecha de compra, previa presentación de la tarjeta de garantía o factura de compra.

CONDICIONES GENERALES DE VENTA

La recepción de un pedido indica por parte del Comprador la aceptación de las presentes Condiciones Generales de Venta, salvo acuerdo particular y escrito entre ambos.

La garantía para acabados especiales de superficie es válida por un año por estar relacionada con la agresión externa según la dureza y la calificación de las aguas. Los acabados en dorado son alterables por la acción nociva de las aguas.

La Garantía ampara:

1. Defecto de material: poros, fisuras, grietas y deformaciones.
2. Defectos de acabado: falta de pulido, rayas y picos.
3. Defectos de acabado superficial: exfoliaciones, manchas, falta de cromo o pintura.
4. Defectos de fabricación: roscas incorrectas, taladros defectuosos, rebabas.
5. Defectos de montaje: ausencia de elementos internos, juntas deterioradas, piezas defectuosas.

Nuestro servicio de Garantía no incluye los defectos presentados por:

1. Instalación incorrecta, móviles por elementos extraños conducidos por el agua.
2. Desgastes ocasionados por elementos químicos añadidos y/o contenidos en el agua.
3. Mantenimiento incorrecto, tanto externo como interno, este último derivado de la limpieza o contacto con productos inadecuados o abrasivos.
4. Desperfectos ocasionados por roces, caídas, golpes, señales de mordaza u otras herramientas.

IMPORTANTE

No se sustituirá un grifo completo cuando la causa sea un elemento intercambiable, siendo repuesto este elemento como garantizado, pero nunca el grifo completo. **No incluye la instalación de la misma.**

RESERVA DE PROPIEDAD

Los productos suministrados serán propiedad del vendedor hasta el pago total de la factura correspondiente.

JURISDICCIÓN

La buena fe que preside las relaciones de Aquahome con todos sus clientes y el deseo de resolver todas las diferencias por vía amistosa, no hacen pensar como posibles las reclamaciones. No obstante, en caso de desacuerdo, ambas partes se someterían a los tribunales de Navalcarnero, con renuncia expresa a cualquier otro fuero.

WARRANTEES

Aquahome faucets are guaranteed for 5 years from manufactures date, previous presentation of the guarantee card or purchase invoice.

GENERAL TERMS OF SALE

For special finishes are warrantied for 1 year due to its related with the external aggressions caused mainly by water hardness and lime. Gold finishes are alterable by harmful water action.

Our warranty covers:

1. Material defects: pores, cracks and deformations.
2. Finishing defects: faults in polish, scratches, sharp points.
3. Surface finishing defects: exfoliation, stains and lack of Chrome or painting.
4. Manufacturing defects: wrong threads or defective drills.
5. Mounting defects: absence of international elements, defective ports.

Our warranty exclude defects caused by:

1. Wrong installation, strange elements conducted by water.
2. Chemical elements added or contained in water.
3. Wrong maintenance, both internal and external.
4. Imperfections caused by frictions, falls, blows, claps or other tools signs.

IMPORTANT

A complete faucet will not be replacing when the defect comes from a changeable element. This element will be replaced under warranty but not complete.

PROPERTY RESERVE

Products supplied will be of seller's property until the total payment of invoice.

JURISDICTION

The good faith that presides over the relations between our Company and our customers, and the desire of solving amicably any problems, make unlikely any possible claims. Nevertheless, all claims will be submitted to Navalcarnero's Court (Madrid, Spain) with express resignation of any other courts



AQUAHOME

bathkitchen style

AQUAHOME BATHKITCHEN STYLE S.L

Apdo. de correos 102

28600 Navalcarnero (Madrid)

Tel: +34 617 430 609

+34 617 430 503

+34 912 797 457

www.aquahomebs.com

comercialventas@aquahomebs.com

departamentocomercial@aquahomebs.com

direccioncomercial@aquahomebs.com